

# PRELIMINARY WORKSHOP: REVIEW OF DRUG DEVELOPMENT IN CLINICAL TRIALS

REPORT

17-21 March 2008 Bangkok, Thailand

## APEC LIFE SCIENCES INNOVATION FORUM



@ 2008 APEC Secretariat

Publication Number : **APEC#208-CT-041**

Produced for  
Asia-Pacific Economic Cooperation Secretariat  
35 Heng Mui Keng Terrace Singapore 119616  
Tel: (65) 68 919 600 Fax: (65) 68 919 690  
Email: [info@apec.org](mailto:info@apec.org) Website: [www.apec.org](http://www.apec.org)



Thai Food and Drug  
Administration



**Asia-Pacific  
Economic Cooperation**

Note: Some of the terms used here do not conform to the APEC Style Manual and Nomenclature. Please visit [http://www.apec.org/apec/about\\_apec/policies\\_and\\_procedures.html](http://www.apec.org/apec/about_apec/policies_and_procedures.html) for the APEC style guide.

Reproduced electronically in April 2007

Prepared By  
Thai Food and Drug Administration  
Ministry of Public Health  
Tiwanont Road Nonthaburi Thailand  
Tel : (66)25907061 Fax : (66)25918390  
Email : [drug@fda.moph.go.th](mailto:drug@fda.moph.go.th) Website : [www.fda.moph.go.th](http://www.fda.moph.go.th)

Produced for  
Asia-Pacific Economic Cooperation Secretariat  
35 Heng Mui Keng Terrace Singapore 119616  
Tel: (65) 68919 600 Fax: (65) 68919 690  
Email: [info@apec.org](mailto:info@apec.org) Website: [www.apec.org](http://www.apec.org)

© 2008 APEC Secretariat

APEC Publication Number: APEC#208-CT-04.1

# Table of Contents

## Part I. Background

- Introduction
- Workshop Information
- Opening Remarks
- Speaker List
- Biography of Speakers

## Part II. Presentations

- Disclaimers
- Overview of ICH and the Global Cooperation Group – Dr Odette Morin  
Status of Clinical Trial Environment in Respective APEC Economies and Non-APEC Country
  - Brunei
  - Chile
  - Indonesia
  - Malaysia
  - Singapore
  - Thailand
  - Viet Nam
  - Saudi Arabia
- Overview of Regulation of Clinical Trials in Canada – Dr Celia Lourenco
- PMDA and Application Procedures – Dr Junko Sato
- Clinical Trial Environment United States (FDA) and European Union (EMA) - Susan D'Amico
- Origin of Clinical Trial Regulations: Canadian Perspective - Dr Celia Lourenco
- Roles and Responsibilities in the Conduct and Assessment of Clinical Trials - Dr Celia Lourenco
- Good Regulatory Practices - Dr Celia Lourenco
- Good Regulatory Practice - Dr Junko Sato
- Regulations & Guidelines: CMC and Non-Clinical - Dr Celia Lourenco
- ICH Guideline on Clinical & Post-Marketing - Dr Junko Sato
- Inspection (GCP & GMP) - Dr Junko Sato

- Overview of Drug Development - Namrata Bahadur
- Overview of Drug Development: regulator's perspective - Dr Celia Lourenco
- Overview of Drug Development Reviewers Perspective - Dr Junko Sato
- Objectives of Clinical Trial Assessment - Dr Celia Lourenco
- Concept of Benefit / Risk - Dr Celia Lourenco
- Qualification Expertise (Canada) - Dr Celia Lourenco
- Qualification Expertise in Japan - Dr Junko Sato
- Quality (CMC) considerations - Dr Celia Lourenco
- Phase I: Overview - Namrata Bahadur
- Clinical Trial Assessment Phase I Clinical Trial - Dr Celia Lourenco
- Clinical Trial Assessment Bioequivalence Studies - Dr Celia Lourenco
- Clinical Trial Assessment Bioequivalent Studies (Generic) - Dr Junko Sato
- Clinical Trial Assessment Phase II - Dr Junko Sato
- Clinical Trial Assessment – Phase III - Susan D'Amico
- Clinical Trial Assessment Patient Protection – Informed Consent - Susan D'Amico
- Concept of product life-cycle, DSUR and Safety Monitoring Board - Dr Junko Sato
- Industry Perspective Data Safety Monitoring Boards and Product Life Cycle - Susan D'Amico
- Pharmacogenomics - Dr Celia Lourenco
- Essential Elements in Clinical Trial Assessment - Dr Celia Lourenco

### Part III. Participants

- List of Participants

### Part IV. Questionnaire Survey Results

- Questionnaire Survey Results



Part I.

---

BACKGROUND

## Project Background

Thailand by Thai Food and Drug Administration, Ministry of Public Health, proposed the APEC Project CT124/2007T or "Capacity Building for Drug Regulatory Agencies on Clinical Trial and Good Clinical Practice" for the year 2007-2008.

In response to APEC's ultimate goal of effective facilitation and liberalization of trade and investment among APEC economies, the key issue of harmonization of standards and regulations has become one of the prime interests because the harmonized standards and regulations would greatly prevent and reduce trade barriers. Regularly, the harmonization of standards and regulations of products is implemented for 'ready to sale' or developed products. Unlike other products, "health care products" or "therapeutic products" needs special attention since the initial stage of research and development. It is because these products directly affect people' health and welfare, and surely to survive in market each therapeutic product must prove itself as effective and safe by evidences shown since the beginning of the research and development process and continuous surveillance throughout its lifecycle. It means that if the product has shown life threatening adverse effects, it would be withdrawn from the market regardless of how much the company invested in research, development or even marketing of the product. Therefore, the promotion and harmonization of international standards and regulations applying to each stage of product's lifecycle are also critical tools to reduce risks and to ensure the sustainability of healthcare products. Particularly, research and development process has become the most significant step to accelerate availability of safe and effective innovative therapeutic products as people request for them to prevent or solve health problems that increase due to changes of environment and people' lifestyles

One of the processes in research and development stage of a therapeutic product, Clinical trial, is a critical research study on human volunteers that is usually used to provide scientific evidence to support the effective and safe use of new pharmaceutical products. More importantly, APEC LSIF's strategic plan indicates that the area of clinical trials would help in quick and effective creation of life sciences innovation. The harmonization of regulatory practices in this area, i.e. Good Clinical Practice (GCP), which is an international standard that every clinical trial needs to comply with in order to ensure the human subjects' rights, safety and the credibility of trial's data, is one of the specified best practices to reach our goals. To ensure that trials are conducted in compliance with GCP and appropriate scientific approach, Drug Regulatory Authorities (DRA) need to review and evaluate drug development in clinical trials and to inspect the conduct of trials at their sites.

The project's objectives are to strengthen DRA's capacity as a part of APEC LSIF's readiness and preparation strategies to handle new therapeutic life science innovations through the best practice area of clinical trials by evaluation of clinical drug development in aspects of quality and safety of investigational pharmaceutical products, inspection of Clinical Trials in compliance with ICH Good Clinical Practice (GCP), and forum for APEC members to discuss and share experiences in controls of clinical trials towards the harmonization of regulatory practices.

The main activities are two training series. The first series include two rounds of 5 day practical workshop on reviewing of drug development in clinical trials, and the second series consist of two rounds of 4 and 5 day practical workshop on GCP inspection.

## Workshop Information

The Preliminary Workshop : Review of Drug Development in Clinical Trials is the first workshop conducted under the APEC Project CT124/2007T. Thai Food and Drug Administration hosted the workshop in Bangkok on 17-21 March 2008. 5 trainers and 20 trainees are from 12 different APEC economies and countries i.e. Brunei, Canada, Chile, Indonesia, Japan, Malaysia, Saudi Arabia, Singapore, Switzerland, Thailand, United States and Viet Nam. The trainers are from both public and private sectors. The trainees are all drug regulatory agencies' officials.

The workshop provided training presentations, exercises and discussion opportunities according to regulatory clinical trial assessment. The main topics were Current Status Of Clinical Trial Environment, Overview Of Clinical Trial Oversight, Drug Development, Quality Considerations, Clinical Trial Assessments of Phase I, II and III. The participants of this workshop also had opportunities to suggest interested topics to cover in the advanced workshop, which was tentatively scheduled in October or November 2008.

Opening and Welcome Remarks  
By  
Mrs. Wilai Bundittanukula  
Senior Expert in Drug Standard  
Thai Food and Drug Administration  
The Pathumwan Princess Hotel, Bangkok  
17<sup>th</sup>-21<sup>st</sup> March 2008

---

Dr Morin, Dr Bahadur, Ms D'Amico, Dr Lourenco, and Dr Sato,  
Distinguished participants,  
Ladies and Gentlemen:

It gives me a great pleasure to welcome all of you and chair the Opening Ceremony this morning to the "Preliminary Workshop: Review of Drug Development in Clinical Trials" jointly organized by Asia Pacific Economic Co-operation and Food and Drug Administration, Thailand.

The significance of Drug Clinical Trials and Capacity Building for Drug Regulatory Agencies are well noticed by several international networks including ASEAN or Association of South East Asian Nations, APEC or Asia Pacific Economic Cooperation, and ICH Global Cooperation Group. The project has first endorsed by ASEAN Working Group in Technical Cooperation since the year 2002. In order to implement the project fully, Thailand has been actively seeking for financial and technical supports. A couple training courses as introductory of the area were conducted in the year 2005 and 2006. Later, Thai FDA proposed this project to APEC in the late of 2006. APEC has approved financial support for the project. And, ICH GCG has agreed to provide technical support.

This workshop is one of the workshops proposed under the APEC project "Capacity Building for Drug Regulatory Agencies on Clinical Trial and Good Clinical Practice". It intends to focus on training for current or future reviewers of Drug Clinical Trials. Moreover, by our speakers' kind assistance, this workshop has been designed to be practical with lectures, examples and exercises to provide skills, encourage participation and exchange information.

Today's workshop is attended by 5 speakers from 5 agencies, those are Pharmaceuticals and Medical Devices Agency (PMDA, Japan), Health Canada, Novartis Pharma(USA), Novartis AG (Switzerland) and ICH Secretariat. Trainees are 20 officers from Drug Regulatory Authorities of 8 different countries including Brunei, Chile, Indonesia, Malaysia, Saudi Arabia, Singapore, Vietnam and Thailand. Therefore, this workshop will provide us a great opportunity to strengthen capacity and a forum to exchange and discuss both technical and regulatory issues.

I would like to take this opportunity to express my sincere thanks to the organizers and honorable speakers. This training program could not have been made possible without ASEAN, APEC, and ICH that foresee the importance of reviewing of clinical trials. I assure you that the results of this program will be implemented by all of us to as one of measures to control drug clinical trials and to ensure the protection of patient safety and promote best quality clinical trials.

Finally, this is an opportune time for me to declare the official opening of the "Preliminary Workshop: Review of Drug Development in Clinical Trials" and I wish all 5 fruitful days of interesting and beneficial program and also that you have a pleasant stay in Bangkok. I warmly welcome you again.

.....

## List of Speakers

No.	Name and Contact Information
1	<p><b>Dr. Celia Lourenco</b>            Manager            Office of Clinical Trials            Therapeutic Products Directorate  <b>Health Canada</b>            Room 5071 Tower B, Holland Cross            1600 Scott Street Ottawa, Ontario Canada K1A 0K9            Tel: 1.613.952.8106            Fax: 1.613.952.9656            Celia_Lourenco@hc-sc.gc.ca</p>
2	<p><b>Dr Junko Sato</b>            Review Director            Office of New Drug I            Pharmaceuticals and Medical Devices            Agency (<b>PMDA</b>)            3-3-2 Kasumigaseki, Chiyoda-ku Tokyo 100-0013 Japan            Tel : +81 (3) 3506 9448            Fax : +81 (3) 3506 9450            sato-junko@pmda.go.jp</p>
3	<p><b>Dr Namrata Bahadur</b>            Head of Clinical Development &amp; Medical Affairs, Emerging Growth Markets (EGM), Basel  <b>Novartis</b> Pharma AG            80A Hauptstrasse, Reinach, CH 4153.            Switzerland            Phone: +41797886471, +41793674574, +41613240515  <a href="mailto:namrata.bahadur@novartis.com">namrata.bahadur@novartis.com</a></p>
4	<p><b>Ms Susan D'Amico</b>            Vice President and Global Head Clinical Quality Assurance            Novartis Pharmaceuticals Corporation            USEH  <b>Novartis</b> Pharmaceuticals Corporation            One Health Plaza            East Hanover, NJ 07936-1080 USA            Phone: +1 8627785985            Fax: +1            susan.damico@novartis.com</p>
5	<p><b>Dr Odette Morin</b>            Director, Regulatory and Scientific Affairs, International Federation of Pharmaceutical            Manufacturers and Associations – <b>IFPMA, ICH secretariat</b>            Chemin Louis-Dunant, 15, P.O. Box 195, 1211 Geneva 20, Switzerland            Phone: 41 22 338 32 07            Fax: ...+41 22 338 32 99  <a href="mailto:o.morin@ifpma.org">o.morin@ifpma.org</a></p>

## Speakers' Biographical Sketches

### 1. Celia Lourenco, Ph.D.



Toronto, Canada.

Dr Celia Lourenco has been the manager of the Clinical Group I, within the Office of Clinical Trials, of the Therapeutic Products Directorate, Health Canada, since August 2007. She is responsible for managing the scientific review of Clinical Trial Applications for a variety of therapeutic areas, including haematology/oncology, allergy, respiratory, immunology, rheumatology, and infectious diseases. Previously, she was a senior clinical evaluator for several years within the Clinical Trials Division of the Centre for Evaluation of Radiopharmaceuticals and Biotherapeutics, Biologics and Genetic Therapies Directorate, Health Canada, where she was involved in the review of Clinical Trial Applications as well as New Drug Submissions for a variety of biologic and radiopharmaceutical products. Dr. Lourenco also has experience in the review of Abbreviated New Drug Submissions for generic products. She holds a B.Sc. and Ph.D. in Pharmacology from the University of Toronto,

### 2. Junko Sato, Ph.D.



Dr Junko Sato is a Review Director in Office of New Drug I, Pharmaceuticals and Medical Devices Agency (PMDA). She received her B.Sc. (1990) in pharmacy from Kyoritsu University of Pharmacy and her Ph.D. (1997) from Jikei University, School of Medicine. From 1990-8, she was an instructor in Jikei University. She researched the mechanism of drug adverse events, especially in antimicrobial agent area.

She is a councilor of the Japanese Society of Chemotherapy, Japanese Association for Infectious Disease, Japanese Society of Environmental Infections Japan Society for Surgical Infection and The Japanese Society of Clinical Pharmacology and Therapeutics. She is also a diplomate of Antimicrobial Agents, Clinical Trial Supervisor, in the Japanese Society of Chemotherapy.

She joined Pharmaceutical and Medical Devices Evaluation Center (PMDEC) in 1998. She visited FDA as a guest reviewer to study the US drug regulatory system from September 2002 to March 2003. She is a member of ICH-E2E Expert Working Group, CIOMS VII, ICH-E2F Expert Working Group. Her specialty is infectious disease. She also works in National Hospital Organization Tokyo Medical Center as an Infection Control Doctor, in 3<sup>rd</sup> Department of Surgery, Toho University School of Medicine as an assistant professor, in Graduate School of Infection Control Sciences as an assistant professor.

She is a member of editorial board of Japanese Journal of Chemotherapy, Japanese Society of Environmental Infections, Journal of Japan Society for Surgical Infection. She is also a member of committee of PK/PD analysis, committee of antimicrobial agents susceptibility surveillance, etc.

### 3. Namrata Bahadur, M.D.



About 20 years experience at academic institutions, pharmaceutical industry and pharmaceutical organizations across India, Asia and Europe. Work experience covers clinical practice, teaching, research, medical affairs, clinical development and regulatory approvals/ liaison. Leadership responsibility included issues of strategic change, marketing and customer management.

- Manage medical affairs, clinical development & regulatory approval/ liaison at country & region.
- Liaise with trade organizations, regulatory bodies, opinion leaders, policy makers in the government across Asia to align expectations of internal/ external stakeholders.
- Build global clinical development – Review and develop capabilities, including pharmacovigilance & audit experience, to conduct global early phase trials in the region.
- Manage budget, resource planning including risks & opportunities at countries & region. Successfully set up financial processes to conform to global standards on internal control & compliance.
- Management reporting – Provide transparency and monitor progress on key business issues & initiatives to senior management.
- Business partnering on strategic initiatives : Provide input to global policies in alignment with regional strategy to support decision making on business strategies.
- led projects involving inter-disciplinary teams from country, regions and global.
- Executive committee member during mergers / business evaluations
- Worked with industry leaders like GlaxoSmithKline, AstraZeneca and Novartis.

### 4. Susan D'Amico



Susan D'Amico is the Vice President and Global Head of Clinical Quality Assurance for Novartis Pharmaceuticals Corporation. As the Global Head she is responsible for establishing the strategic direction and management of a large team of clinical quality professionals located in the North America, Latin America, Europe, and Asia-Pacific. The focus of the team is provide and independent assessment of quality and compliance in the disciplines of GCPs, Pharmacovigilance, and Computer System validation (e-compliance).

Susan is a veteran of over 28 years of experience in the pharmaceutical industry. The majority of her career was spent at Johnson & Johnson where she held positions of increasing authority leading to senior management positions in both global clinical trial management/operations and clinical quality assurance. During her tenure in clinical operations she served as program leader for a number of successful products and has the breadth of drug development experience from first in man to launch. While at J&J as Global Head CQA, Susan established one of the first in industry pharmacovigilance quality assurance units with the focus on drug safety. In addition, she expanded CQA operations to Asia-Pacific and successfully integrated CQA departments from several independent pharma companies acquired by J&J.

Susan holds degrees from Marymount University and Thomas Jefferson University where she earned a Bachelors of Science in Nursing.



## 5. Odette Morin, Ph.D.



Dr Odette Morin obtained a B.Sc. in Biochemistry in 1974 at Laval University, Quebec, Canada, and a Ph.D. in Physiology, Molecular Endocrinology, at the same university. She went on to do post-doctoral work in Endocrine Physiopathology at Nice University, France.

Upon completion of her studies, she joined Laval University in 1982 as Research Associate and three years later as Associate Professor in the Department of Experimental Medicine, Division of Oncology, where she headed a research group for six years.

She then joined Sandoz Canada (now Novartis) for about three years as Scientific Expert in the Medical Liaison Service, Division of Scientific Development. Some duties of this position were to provide input to clinical trial design and to train medical representatives in endocrinology and oncology.

Since April 1993, Dr. Morin has been working for the International Federation of Pharmaceutical Manufacturers and Associations (IFPMA), Geneva, Switzerland, and her current position is Director, Regulatory and Scientific Affairs. The core priorities of this job include regional and global regulation (International Conference on Harmonization of Technical Requirements for the Registration of Pharmaceuticals for Human Use - ICH), information (e.g., IFPMA Search Portal for clinical trials initiative), and specific projects dealing with key WHO projects and other international agencies (e.g., ethics of biomedical research). With respect to ICH, Dr. Morin is in charge of the daily coordination of the ICH Secretariat, a Member of the ICH Steering Committee and Chair of the ICH MedDRA Management Board.

---

Part II.  
Presentations

## Disclaimers

The information within all presentations in this report is based on the presenters' expertise and experience, and represents the views of the presenters for the purposes of a training workshop

## ***Overview of ICH and the Global Cooperation Group***

**Dr. Odette Morin**  
Director,  
ICH Secretariat  
IFPMA Regulatory Affairs

International Conference on Harmonisation of Technical  
Requirements for Registration of Pharmaceuticals for Human Use



## **Objectives**

- To provide a brief overview of ICH
- Explain the role of the Steering Committee
  - Responsibilities
  - Membership
  - Function
- Report on the mandate of the Global Cooperation Group
  - Shift from information-sharing to training
  - Membership (RHIs and Individual DRAs)

# ICH

## INTERNATIONAL CONFERENCE ON HARMONISATION of Technical Requirements for the Registration of Pharmaceuticals for Human Use

<http://www.ich.org>

Hosted by ICH Secretariat  
IFPMA-Geneva, Switzerland



3

## ICH Background

- Unique harmonization project involving the regulators and research-based industries of US, EU and Japan—**started in 1990**
  - WHO, Canada, and EFTA are observers
- Well-defined objective: to improve efficiency of new drug development and registration process
- Accomplished through the development and implementation of harmonized guidelines and standards



4

## ICH Steering Committee Responsibilities

- The body that governs ICH
- Determines ICH policies and procedures
- Decides on the adoption of ICH projects
  - Selects topics for harmonization
  - Endorses the creation of Expert Working Groups
- Monitors and facilitates the progress of Expert Working Groups
- Signs off ICH documents

---

ICH

5

## ICH Founding Members

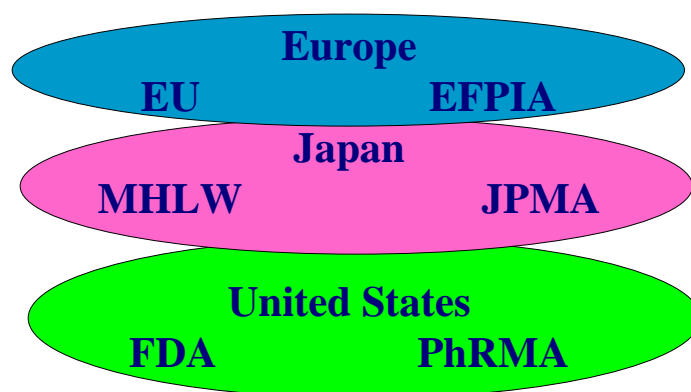

Observers: WHO, Canada, EFTA

---

ICH

6

## ICH Structure

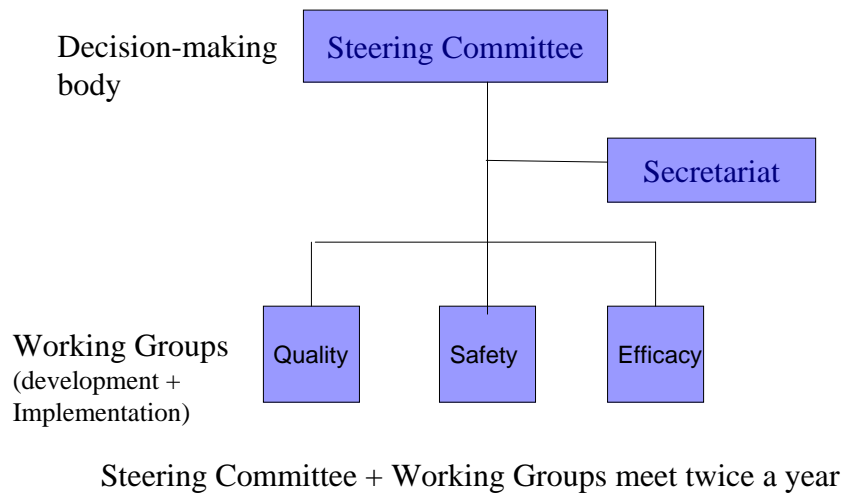

ICH

7

## Steps of ICH Harmonization

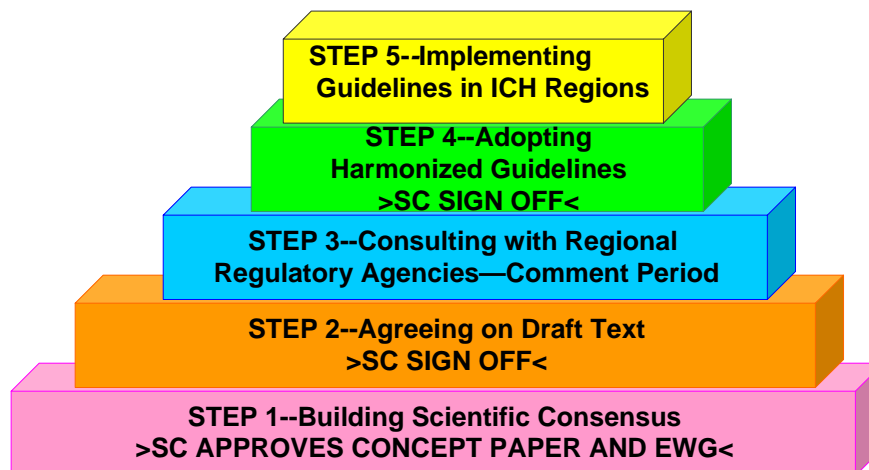

ICH

8

## Accomplishments

- 50+ harmonized guidelines on technical requirements (quality, safety, efficacy)
- Medical dictionary (MedDRA)
- Electronic standards (ESTRI, E2B)
- Common format and electronic specification for marketing applications : CTD and eCTD

## ICH: Keys to Success

- Effective management and administration
  - Through Secretariat and Steering Committee
- Limited number of members with common focus and objectives
- Comparable regulatory, technical and financial capacity of participants
- Commitment of all parties to implement harmonized guidelines
- Well-defined process



# - The ICH GCG - Transparency & Communication

International Conference on Harmonisation of Technical  
Requirements for Registration of Pharmaceuticals for Human Use



## Interest beyond the 3 regions

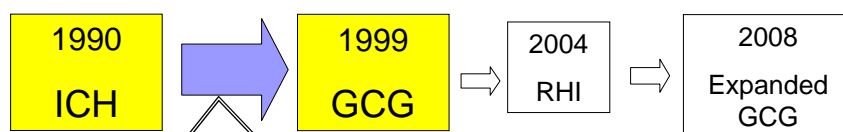

Initially focused on development of guidelines  
and standards for use in the ICH “regions”

Growing interest in ICH products beyond ICH  
countries



## Global Cooperation Group (GCG)

- Established March 1999 as sub-committee of ICH Steering Committee
- Formed to respond to this growing interest in ICH guidelines
- Name reflective of desire to establish links with non-ICH regions
- Same membership as ICH

## .....Not enough

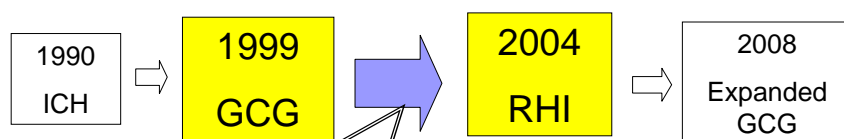

More proactive approach was necessary.

Decided to invite **representatives from non-ICH regions** to be part of GCG.

## Regional Harmonization Initiatives

- **APEC**
  - Asia-Pacific Economic Cooperation
- **ASEAN**
  - Association of the Southeast Asian Nations
- **GCC**
  - Gulf Cooperation Council
- **PANDRH**
  - Pan American Network for Drug Regulatory Harmonization
- **SADC**
  - Southern African Development Community



15

## Adopted new GCG mission statement

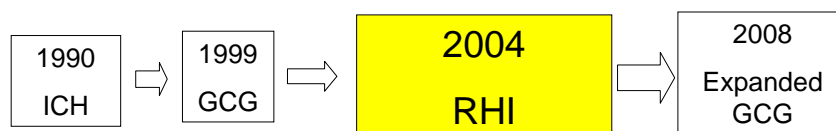

May 2005, Brussels:

*“To promote a **mutual understanding** of regional harmonization initiatives in order to facilitate the harmonization process **related to ICH guidelines** regionally and globally, and to **facilitate the capacity** of drug regulatory authorities and industry to **utilize them**”*



16

## Training: a Key Focus

Framework and mechanisms established:

- Strategy document lays out principles for effective, strategic use of training resources
- Clearing house of training events created to identify opportunities
- Procedures and templates under development to improve efficiency and effectiveness of process – including 2 year planning cycle
- Public access: training materials to be posted to ICH website



17

## ICH/APEC Q8,Q9,Q10 Workshop: September 13-14, 2008, Seoul, Korea

- First training request endorsed and coordinated through GCG
- Workshop confirmed value of such events in promoting a better understanding of the ICH guidelines and opportunities/challenges associated with their use
- Over 200 participants from 17 countries
- Model for future training workshops:
  - Shared responsibility: APEC, ICH, KHIDI/KFDA
  - Interactive session
  - Representation from across three ICH regions



18

## Additional Training Activities

- APEC workshops on clinical trial assessment (Bangkok: March, August 2008)
- APEC workshops on GCP inspection (Bangkok: May, November 2008)
- PANDRH (Mercosur region) Quality workshop related to risk-based GMP inspection approach (Sao Paulo: falls 2008)

## Further progress – Expanded GCG

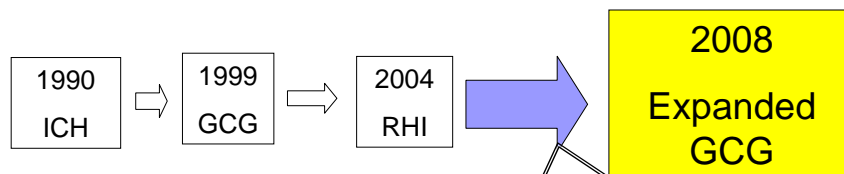

ICH has recognized need for changes to mirror global face of drug development.

In Oct 2007, the ICH SC has decided to **invite a number of individual Drug Regulatory Authorities.**

## Shared Objectives - Complementary Actions: Facilitate understanding and use of ICH Guidelines

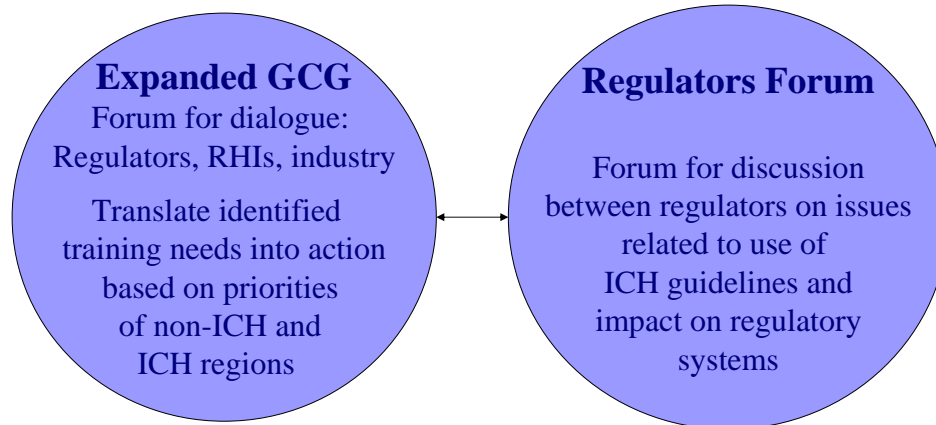

## Conclusion

- Considerable progress to date in promoting a better knowledge of ICH guidelines and the challenges faced by other regions in their use
- GCG efforts have evolved from information sharing to active dialogue to results-oriented actions
- Important new developments should further accelerate progress
- Learning from each other, in a climate of trust and cooperation, can greatly increase the strength of all harmonization efforts
- Moving towards more efficient regulatory systems and increased availability of safe, effective and quality pharmaceuticals on a global level



**Thank you for your  
attention**

International Conference on Harmonisation of Technical  
Requirements for Registration of Pharmaceuticals for Human Use

**ICH**

# Status of Clinical Trial Environment in BRUNEI DARUSSALAM

Presented by Mrs Jamilah Metussin

## *Disclaimer*

*The information within this presentation is based on the presenter's expertise and experience, and represents the views of the presenter for the purposes of a training workshop*

Mrs Metussin's presentation was based on these answers to questionnaires

1. Please briefly describe the regulatory framework in place to authorize and monitor clinical trials.

To date, we have not conducted any clinical trial in the country. However, currently we are in the process of formulating the Guideline on the Medical Research and Ethic Committee at the hospital level.

The Medicine Order which is still waiting for approval has a provision on the clinical trial.

2. How long has the assessment and inspection of clinical trials been undertaken?

N/A

3. What guidelines are followed for assessment and inspection (e.g., WHO, ICH, etc.)?

The guideline is drafted using WHO and ICH as a reference.

4. How many staff are engaged in the assessment and inspection activities related to clinical trial oversight? Do these represent in-house resources or outside experts, or a mix?

N/A however during our discussion for future control of the clinical trial the discussion group on medical research and ethics committed have the



intention for the assessment and inspection activities related to clinical trial to be done by a mix of resources.

5. What are the qualifications for assessors and inspectors?

Minimum requirement - Degree in Sciences of related field.

6. What training programs currently exist for assessors and inspectors?

N/A – Only there was a short training course on good clinical practice in March 2007 organized by the Medical Department with selective participants comprised of pharmacist and doctors.

7. What types of clinical trials are currently conducted in your country? If possible, Please describe percentages and numbers in terms of clinical trial phases (including Bioequivalence studies) and foreign versus domestic.

N/A

8. What do you consider the greatest challenges to the regulatory oversight of clinical trials?

1. Assessment on the conduct of the clinical trial
2. Compliance to the methodology as well the ethics.

9. What do you hope to gain from attending the above mentioned workshops?

To have further insight; and in-depth knowledge on how the clinical trial is conducted and its related activities especially from regulatory perspective.

## REGULATORY FRAMEWORK FOR CLINICAL TRIALS IN CHILE

Ps. Miguel Gonzalez G  
Ab. Luis Brito R.  
Institute of Public Health



### *Disclaimer*

- *the information within this presentation is based on the presenter's expertise and experience, and represents the views of the presenter for the purposes of a training workshop*

ISSP



## CHILE: ESTIMATED POPULATION JUNE 30, 2006

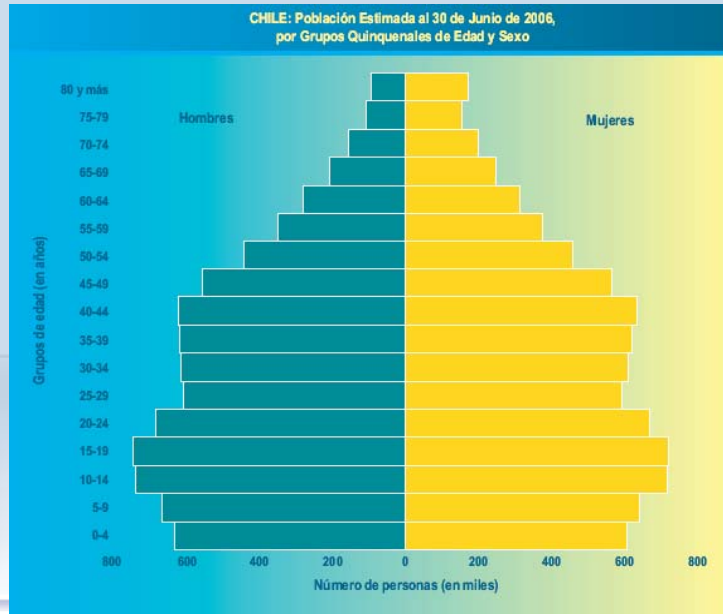

## AN AGING COUNTRY

1960

2000

2025

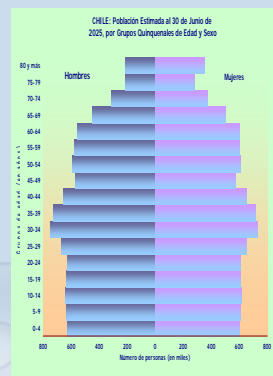
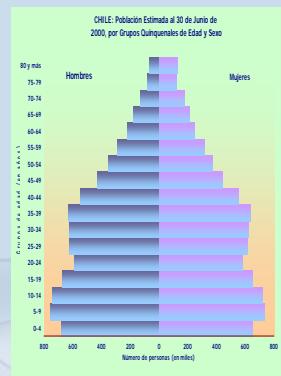
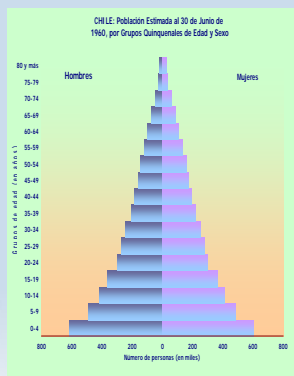

## GRADUAL OVERCOMING OF POVERTY

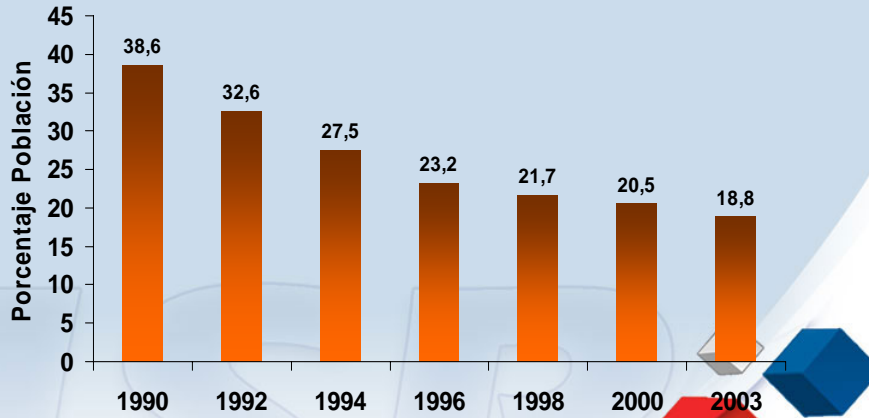

- Evolución pobreza 1990-2003. Encuesta Casen, MIDEPLAN

## MORTALITY per CAUSES OF DEATH

Chile, 1970, 1990 y 2004

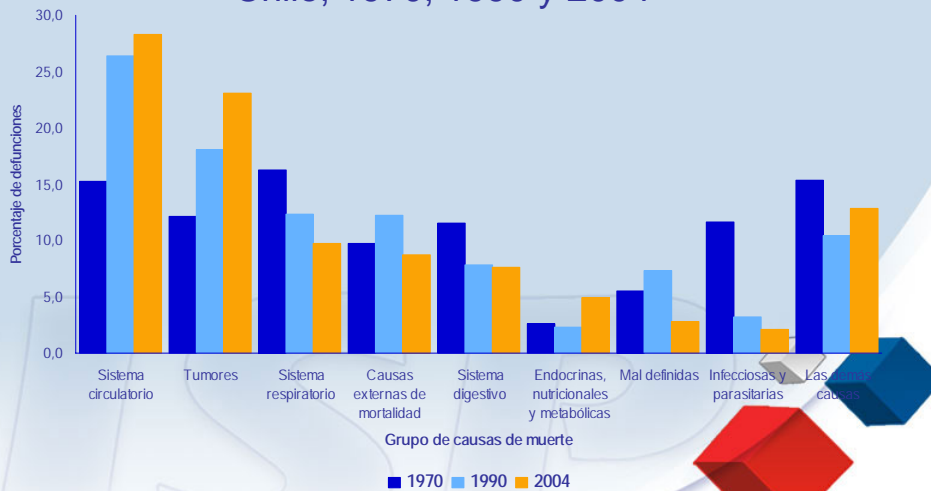

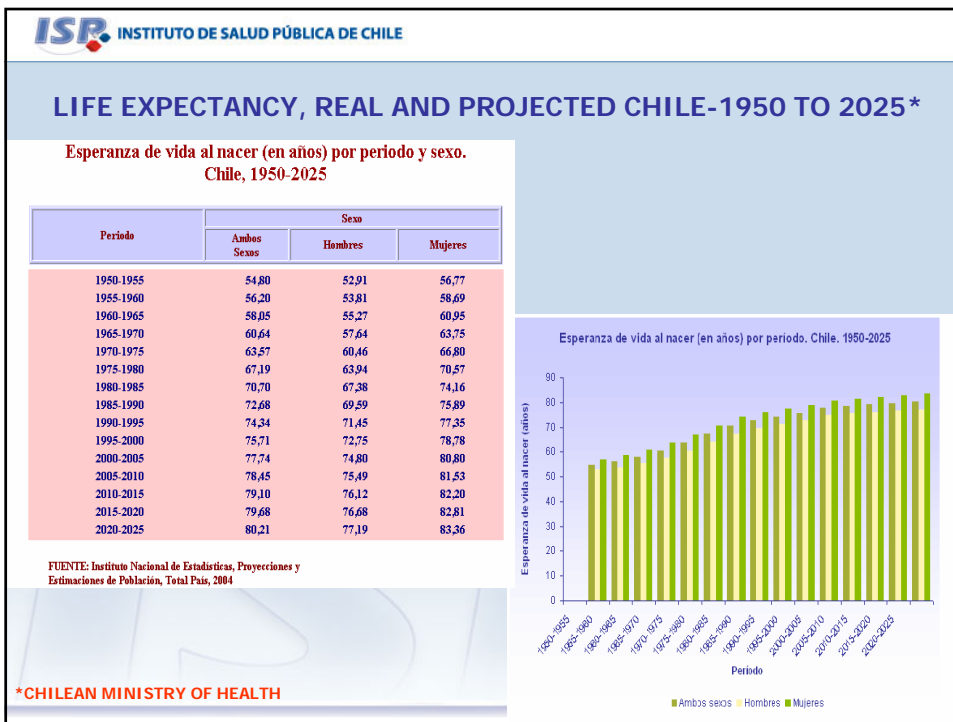

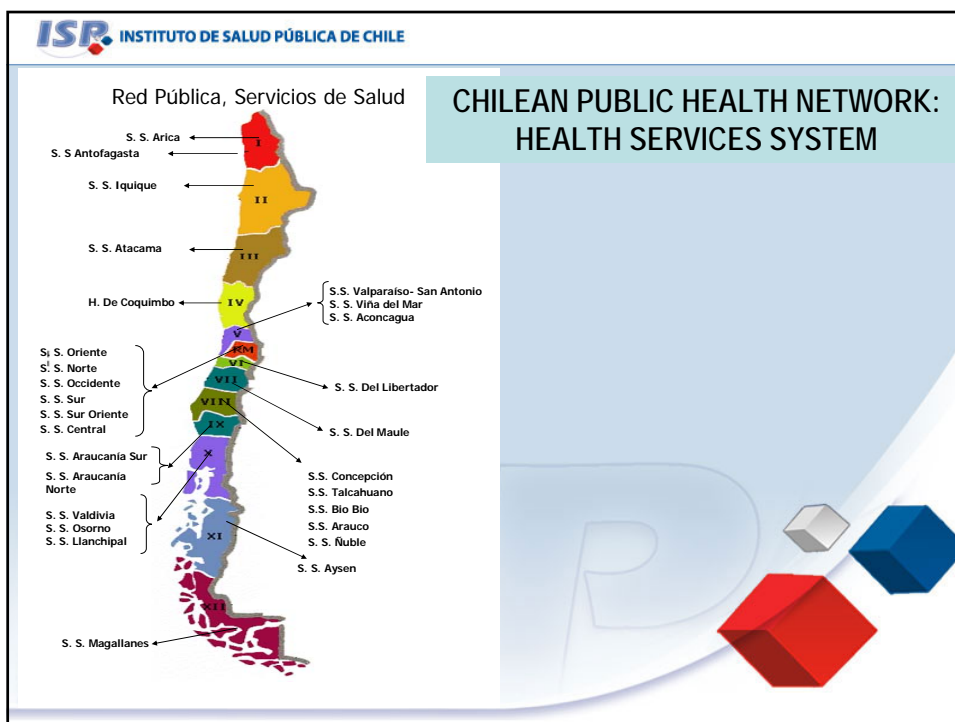
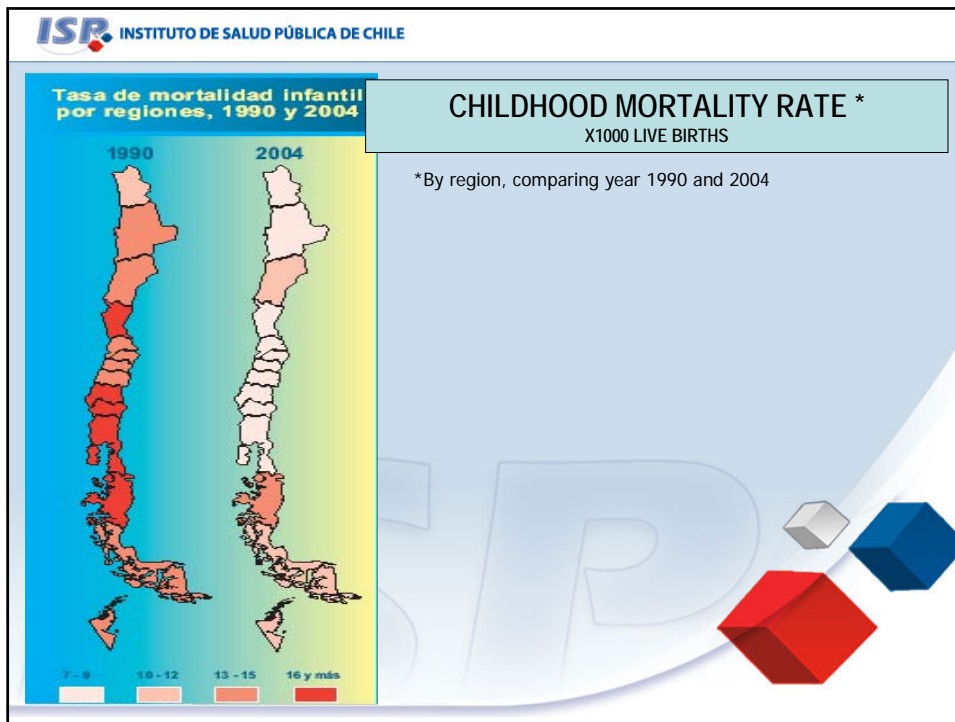



## Región Metropolitana



## ISP ORGANIZATIONAL CHART

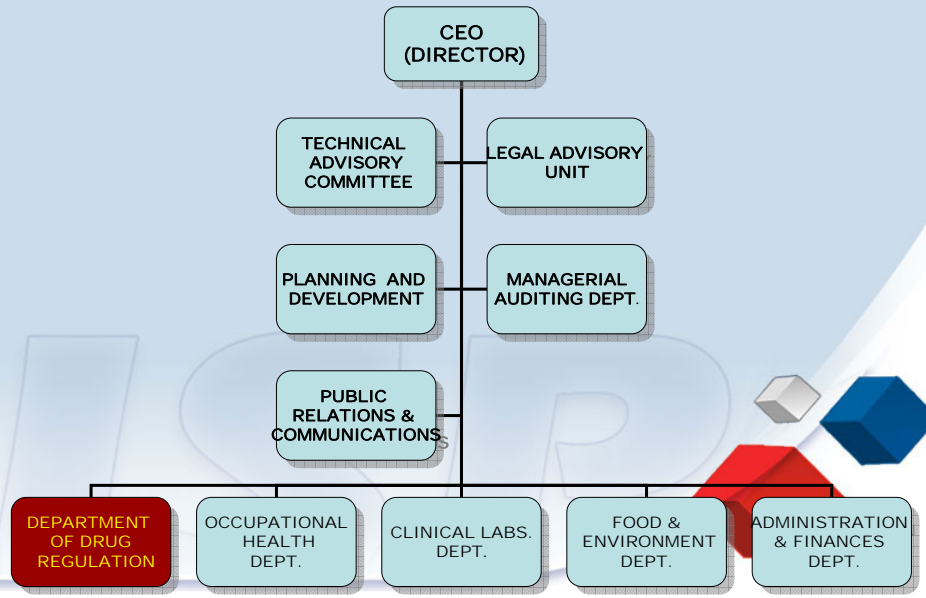

## ORGANIZATIONAL CHART DEPARTMENT OF DRUG REGULATION

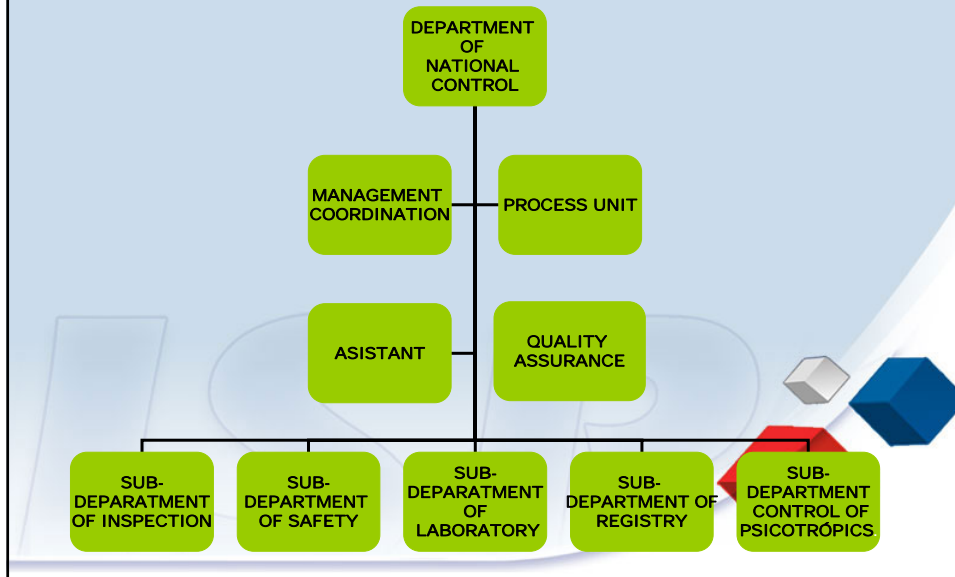



## MISSION

**“ Improvement of Public Health, Guaranteeing Quality of Goods and Services through the Strengthening of Reference, Inspection and Regulation.”**

ISR



## DEPARTMENT OF DRUG REGULATION

- Authorization, Control and Inspection of the Pharmaceutical and Cosmetic Production Plants and of the External Quality Control Laboratories
- Evaluation, Registry, Control and Certification of Pharmaceutical Products, Cosmetics and Household and Sanitary use Pesticides.
- Authorization and Inspection of Medical Devices Production and Importation Industry

ISR



## DEPARTMENT OF DRUG REGULATION

- Post-marketing Drug Surveillance.
- Post-marketing Medical Device Surveillance.
- Post-marketing Cosmetical Product Surveillance.
- Biological Products lot to lot Analysis.
- Drug Information Reference Center.
- Evaluation and Authorization of Clinical Trials that use Drugs not Registered in the Country.

## Regulatory Organization in Chile

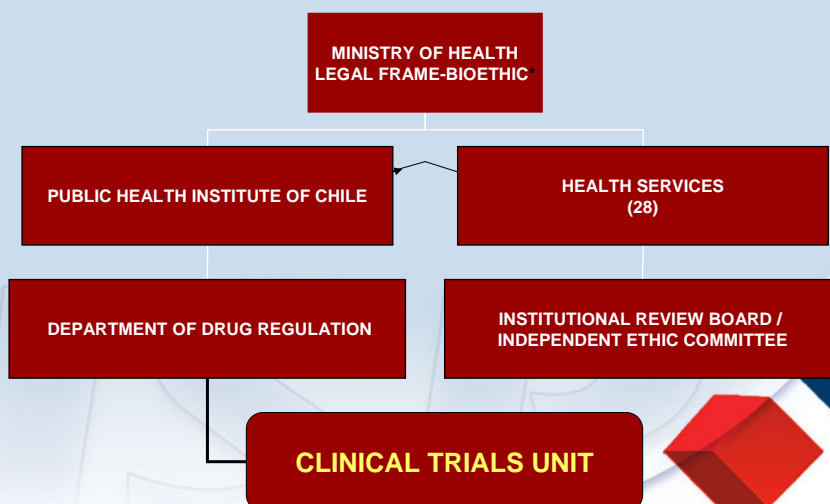

\* Approved by Congress

## Regulatory Organization in Chile\*

- **Ministry of Health, Bioethical Unit**
  - Ministry of Ethics Committee: review and authorize Clinical Trials in which three or more Health Services participate or in Vaccination Trials .
- **Scientific Ethics Committee of Health Service**
  - Review and authorize Clinical Trials that are made in its Geographical Area.

\*UNDER REVIEW, NEW LEGAL BODY APPROVED RECENTLY

## Regulatory Organization in Chile

Clinical Trials Unit, Chilean Public Health Institute (ISP)

### Objective:

To review and authorize Clinical Trials in order to allow entry into the country of non registered products.

## Regulatory Documentation Required for Authorization at ISP

- Investigational Protocol
- Informed Consent
- Authorization of the corresponding Ethics Committee
- Principal Investigator's C.V.
- Participant Insurance
- Principal Investigator's Brochure

## Criteria used for Evaluation and Authorization

- Ethically acceptable :
  - Informed Voluntary Consent
  - Random Selection of the participants
  - Equal benefit opportunity potencial
  - Favorable Risk / Benefit Ratio in order to minimize risks and maximize benefits
  - Independent Evaluation
  - Value of the Investigation: improvement of health, welfare or knowledge of the community .

## Criteria used for Evaluation and Authorization

- Ethically acceptable (Cont.):
  - Respectful of the participants will
  - Change of opinion
  - Information privacy and confidentiality
  - Knowledge of new information
  - Protection from adverse events
  - To be of Scientific Value
  - Appropriate methodology and design to obtain statistically significant results

## Average Approval Time of clinical trials 2000-2007 (working days)

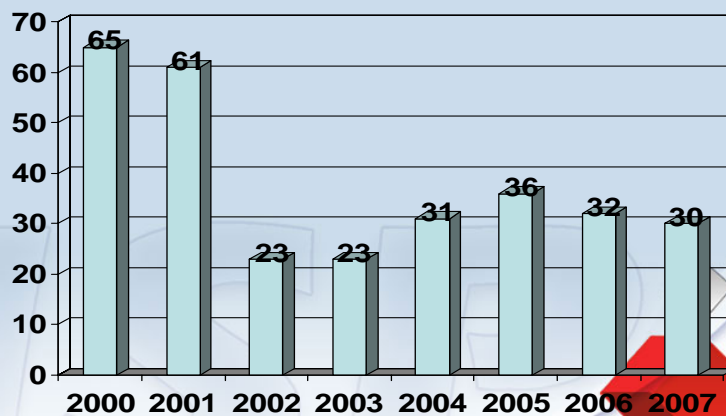

## Improvements 2004 - 2007

- Check-list for Inspection of sponsors, Investigation sites , Management and Distribution of products in the investigation sites.
- OPS/ OMS coordination to harmonize Regional Regulations.
- Coordination of Ministry of Health Bioethical Unit with Public Health Institute
- Approval in required time frames.



## Improvements 2004 -2007

- Database of notified adverse events by sponsors.
- Action taken before possible risks to the participants.
- Formulation of Quality and Ethicals Indicators implemented in the clinical trials
- ISP Regulatory Inspections (ongoing)



### CLINICAL TRIALS- RESEARCH PHASE 2002-2006

phase /year	2002	2003	2004	2005	2006	TOTAL
I	1	0	4	2	3	10
II	13	9	28	31	31	112
III	49	45	62	71	85	312
IV	3	3	8	1	7	22
TOTAL	66	57	102	105	126	456

### Clinical Trials Research Phase

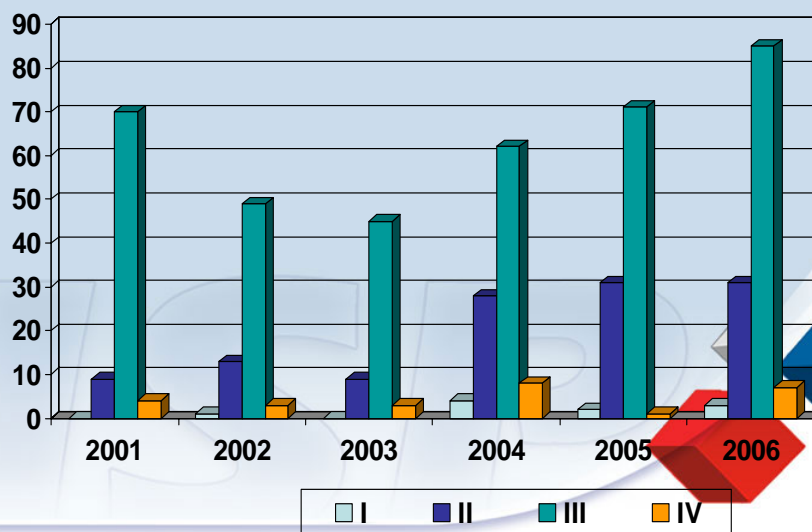

## N° of Clinical Trials CHILE (2001-2006)

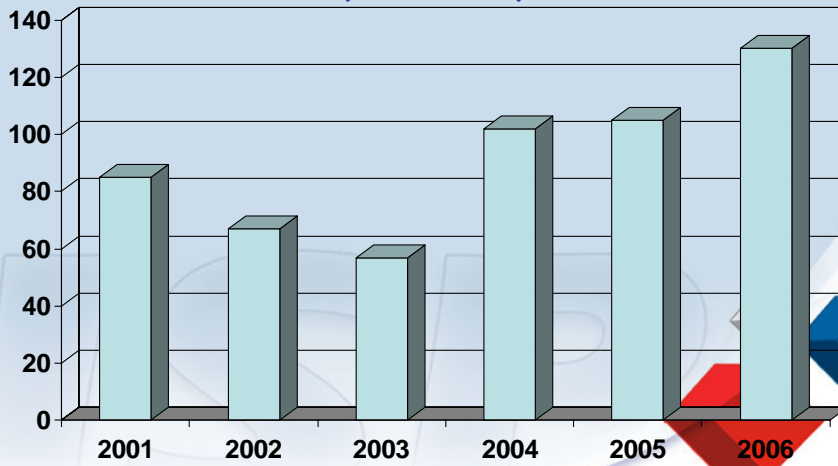

## Chilean Trial Distribution Pharma/CRO 2001-2007

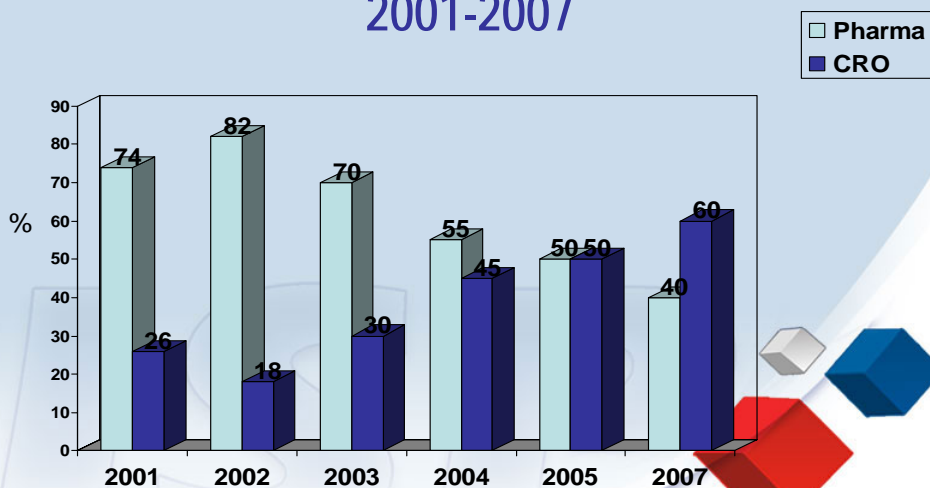



## Future Challenges

- Update Meetings with Sponsors and CRO's
- Inspection of Research Sites (7 inspections until now)
- Evaluating the Causes of Notified Adverse Events (SAEs).
- Modification of current Regulation according to PARF Network (PAHO/WHO).
- Ethical Committee Definition
  - Composition
  - Accreditation
  - Training



# CLINICAL TRIAL AUTHORIZATION IN INDONESIA

Bangkok, 17 March 2008

1

## *Disclaimer*

- *The information within this presentation is based on the presenter's expertise and experience, and represents the views of the presenter for the purposes of a training workshop*

2

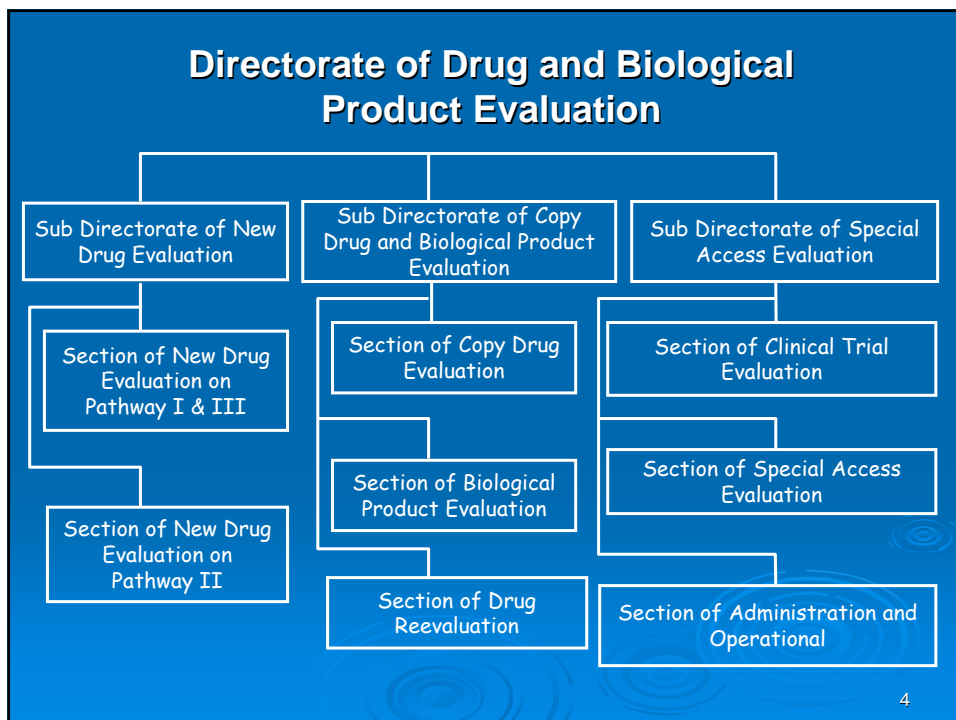
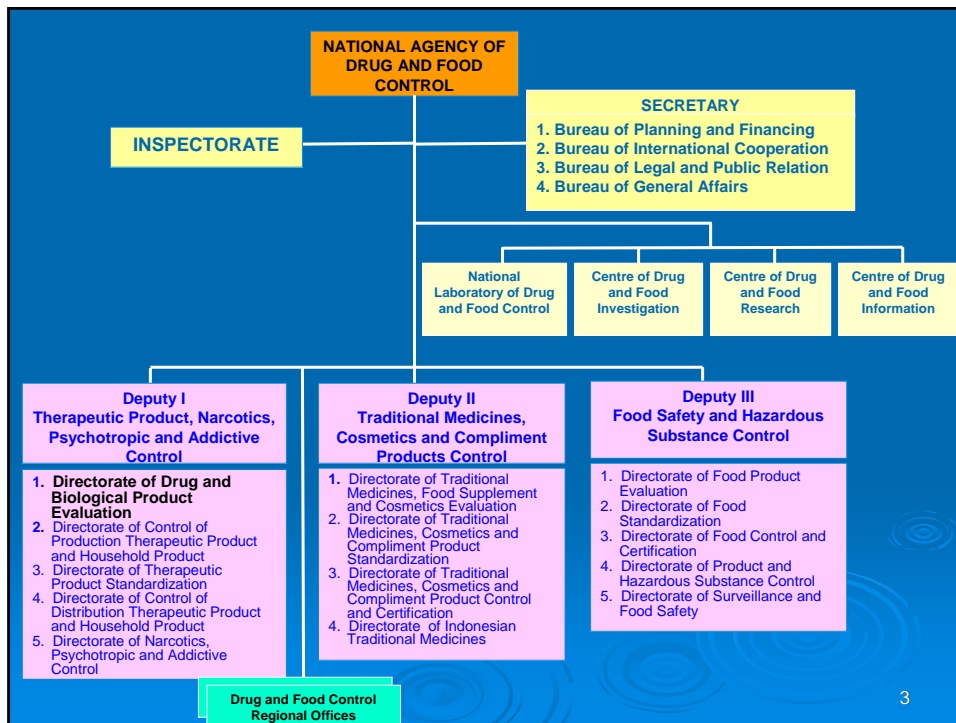

## Scope of Regulatory Authority for Clinical Trial

### CT Authorization :

- Established since 2001
- Law : Health Law, 1992  
Consumer Protection Law 1999
- Decree : - NADFC Decree on Procedures for Clinical Trial (CT) No. 02002/SK/KBPOM, February 2001
- Guideline : Indonesian Guideline for Good Clinical Practice (2001: Indonesian Version, 2002 : English version)
- SOP : 1. Evaluation Process for Application of Clinical Trial Conduct  
2. Evaluation process for Application of Import License
- **Regulatory Authorization**
  - Clinical Trial approval
  - Drug import license

5

Continue ....

### GCP Inspection :

- Law : Health Law, 1992  
Consumer Protection Law 1999
- Decree : NADFC Decree on GCP Inspection  
No. HK.00.05.3.4991, 11 Nov 2004
- SOP : GCP Inspection  
GCP Checklist  
Manual Checklist
- GCP Inspection Report Form

6

## Application of CT Conduct

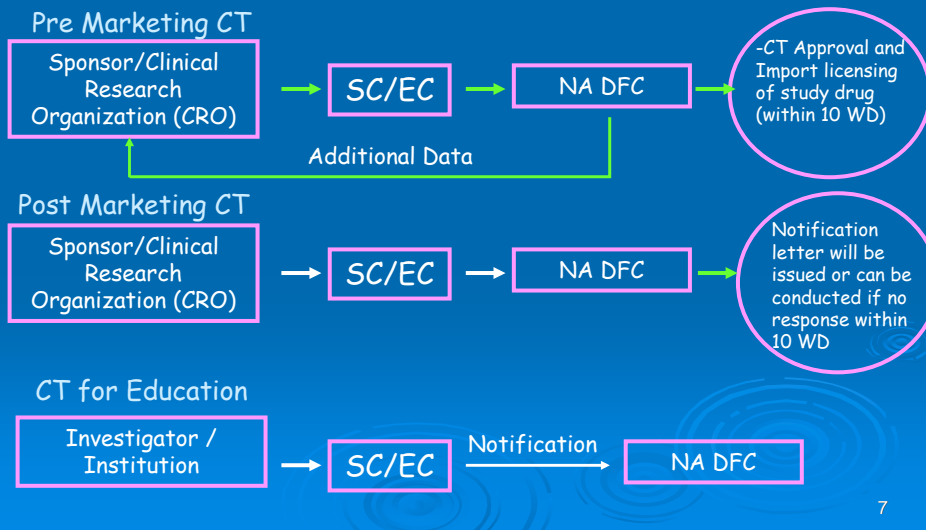

## CLINICAL TRIAL CONDUCTED IN INDONESIA

- Requirement for drug registration :
  - Drugs used in National Health Programs, such as contraceptives, immunizations and antimalarial drug
  - Inadequate clinical data, local & overseas :
    - Bridging study
    - Confirmatory study
- Need of pharmaceutical industries for better data from various multicentre - multinational studies

## CT APPLICATION IN INDONESIA \*

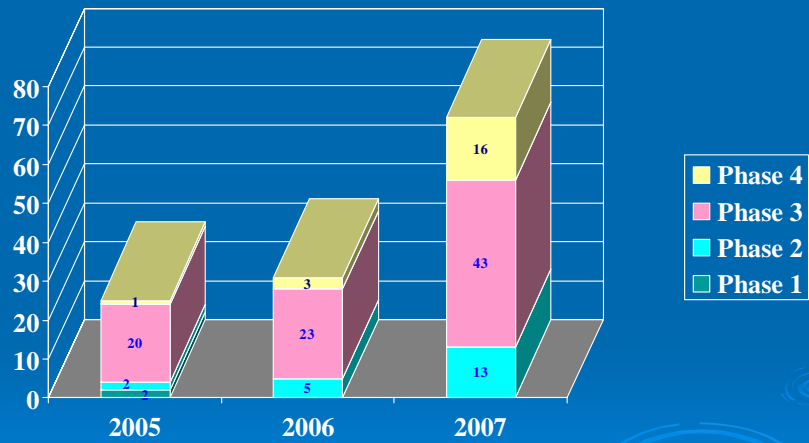

\* Not including Bioequivalence Studies

9

## GCP Inspection

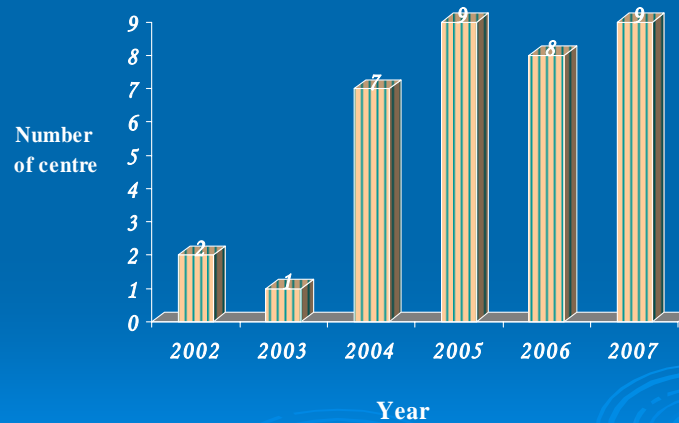

10

## Future Challenges

- To increase GCP compliance among parties involved in CT conduct
- To be one of the CT centers for global studies
- Exchange information in the global study, particularly on SAE, CT termination, CT rejection

11

THANK

YOU

12





## REGULATION OF CLINICAL TRIAL IN MALAYSIA

---

Dr. Kamaruzaman Saleh  
Head, Clinical Trial and Compliance Section  
National Pharmaceutical Control Bureau  
Ministry of Health Malaysia



### *Disclaimer*

---

- *The information within this presentation is based on the presenter's expertise and experience, and represents the views of the presenter for the purposes of a training workshop*

# OUTLINE

- Introduction
- Regulation and Ethical Oversight of Clinical Trial in Malaysia
- Guidelines and Legal Requirements
- Compliance

The screenshot shows the homepage of the National Medical Research Register (NMRR) website. The browser address bar displays <https://www.nmrr.gov.my/>. The page features a blue header with the NMRR logo and the tagline "Advancing Medical Research in Malaysia". A navigation menu includes "HOME", "FEEDBACK", "USERS INSTRUCTION", and "CONTACT US". The "USERS INSTRUCTION" link is circled in red. The main content area is titled "National Medical Research Register" and describes the web-based tool designed to support the implementation of the National Institute of Health (NIH) guideline. It lists current MOH policy requirements, such as registration of all research involving MOH personnel or funded by MOH grants, and approval of research by the MOH Research and Ethics Committee (MREC). A list of four points details the benefits of the NMRR, including online registration, submission, and tracking of research. On the right side, there is a "NMRR Login" section with a "Sign in to NMRR" button, an "E-mail:" field, a "Password:" field, and a "Sign in" button. Below the login section, there is a "Need Assistance?" section with contact information for the NMRR Admin at the Clinical Research Centre, 3rd Floor, Dermatology Block, Hospital Kuala Lumpur, Jalan Pahang, 50586 Kuala Lumpur. The contact details include Tel: 03 - 2698 0310, Fax: 03 - 2691 1682, and Email: [nmrr@nic.gov.my](mailto:nmrr@nic.gov.my). The footer of the page includes the text "Internet".

# Regulation and Ethical Oversight of Clinical Trial in Malaysia



## Ensuring Ethical Research: A joint responsibility

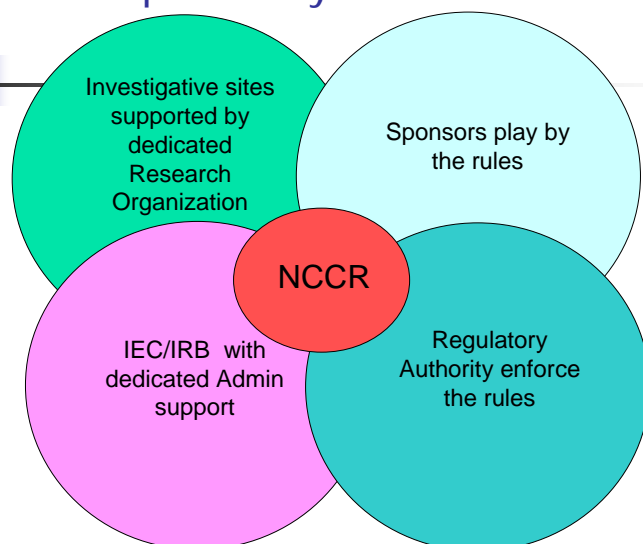

## 1. National Committee for Clinical Research(NCCR)

---

- Forum for dialogue among all parties: Regulatory authority, IECs, Sponsors, Investigators from MOH/Universities/ Private hospitals
- Promulgate & implement various guidelines:
  - GCP, Bioequivalence (BE) studies, GLP, Guidelines for Application For CTIL/ CTX etc
- Training on GCP
- Site-inspection for clinical trials
- Review processes for approval of clinical trials

## 2. Investigative sites & Research organization

---

This is where the action is; where investigators enroll patients into the trial

Ethical trial conduct & compliance requires:

- Adequate resources to conduct the trial
- Training, eg GCP certification
- Independent monitoring of trial conduct



### 3. Sponsors

---

- Sponsor pay for the research, and own the IPR
- Mostly industry sponsors (mostly drug trials) or government grant agency (eg NIH of the MOH, MOSTE)
- Recruitment of well qualified investigators
- Avoid undue influence of investigators and patients
- Independent monitoring /audit by sponsors: common practice for industry



### 4. IEC/ IRB

---

"An independent body constituted of medical professionals and non-medical members whose responsibility it is to ensure the protection of the rights, safety and well-being of human subjects involved in a trial and to provide public assurance of that protection, by, among other things, reviewing and approving the trial protocol, the suitability of the investigator(s), facilities, and the methods and material to be used in obtaining and documenting informed consent of the trial subjects." ICH GCP 1.27

- In Malaysia, for MOH/private sites, this is the **Medical Research & Ethics Committee of the MOH (MREC)**; universities have their own IECs.

## Application for Conduct of Clinical Trial in MOH, Malaysia



## 5. Regulatory Authority

- Drug Control Authority (DCA)  
**An authority established for the purpose of regulating the Control of Drugs and Cosmetics Regulations, 1984**
- DCA has a broad public protection mission to ensure the safe use of regulated products that are themselves safe and efficacious
- Ensure Implementation of trial related guidelines and legislation

## Guidelines and Legal Requirements

---

### Guidelines:

- Malaysian Guidelines for GCP (Updated 2004)
- Guidelines for Application of CTIL and CTX in Malaysia
- NIH Guideline for Research conduct in MOH

### Laws

- Control of Drugs and Cosmetics Regulation 1984
- The Poison Regulation (Psychotropic Substances) 1989
- Sale of Drugs Act 1952

### Malaysia GCP Guidelines "5.20.3

The DCA will enforce the rules and punitive action will be decided by the DCA

## 4. Malaysian GCP

### 4.1 Investigator's Qualifications and Agreements

---

4.1.1 The investigator (s) should be qualified by education, **approved training in Good Clinical Practice certification** and experience to assume responsibility for the proper conduct of the trial, should meet all the qualifications specified by the applicable regulatory requirement (s), and should provide evidence of such qualifications through up-to-date curriculum vitae and/ or other relevant documentation requested by the sponsor, the IRB/IEC and/or the regulatory authority (ies)

## Control of Drugs and Cosmetics Regulations 1984 (Revised 2006)

---

### **Regulation 29. Directions**

- (1) The Director of Pharmaceutical Services may issue written directives or guidelines to any person or a group of persons as he thinks necessary for the better carrying out of the provisions of these Regulations and in particular relate to-
- (a) clinical trials or





---

(2) Any person who contravenes any **directives or guidelines** issued by the Authority under subregulation (1) commits an offence.



## Control of Drugs and Cosmetics Regulations 1984

---

*Regulation 12(1)(c): Clinical Trial Import Licence (CTIL)*

*A Clinical trial import licence in Form 4 in the Schedule,*

- *authorising the licensee to import any product for purposes of clinical trials,*
- *notwithstanding that the product is not a registered product*



## **Control of Drugs and Cosmetics Regulations 1984**

---

### **Regulation (15) Exemptions**

#### **Regulation 15(5) : Clinical Trial Exemption (CTX)**

“Any person who wishes to manufacture any products solely for the purpose of producing samples for registration/clinical trials under these Regulations may on application be exempted by the Authority from the provisions of regulation 7(1).”



## **Contravention of Regulation 7(1) of the Control of Drugs and Cosmetic Regulations 1984**

---

- The penalty comes under parent acts Section 12, Sale of Drug Acts 1952 (Revised 1989)



## CTIL and CTX Application

### CTIL Application

- For unregistered products.
- Product when used or assembled (formulated or packaged) in away different from the approved form.
- Form BPFK 442.4
- Fees : RM 500 for each product
- Licence A for Poisons (where applicable)
- DCA approval based on:-
  - approval from IRB/IEC
  - complete information on investigational products

### CTX Application

- For unregistered products-manufactured locally.
- Form BPFK 443.1
- Fees : Free of charge
- Licence A for Poisons (where applicable)
- DCA approval based on:-
  - approval from IRB/IEC
  - complete information on investigational products



## CTIL and CTX Requirements

### Who can apply?

- Principal Investigator (PI) or
- An authorized person from a locally registered pharmaceutical company (sponsor)

### Details Required

- Annex A- Clinical Trial Protocol
- Annex B-Pharmaceutical Data
- Annex C-Investigator Brochure

\* CTIL/CTX containing a 'Scheduled Poison, should be made by a licence A holder

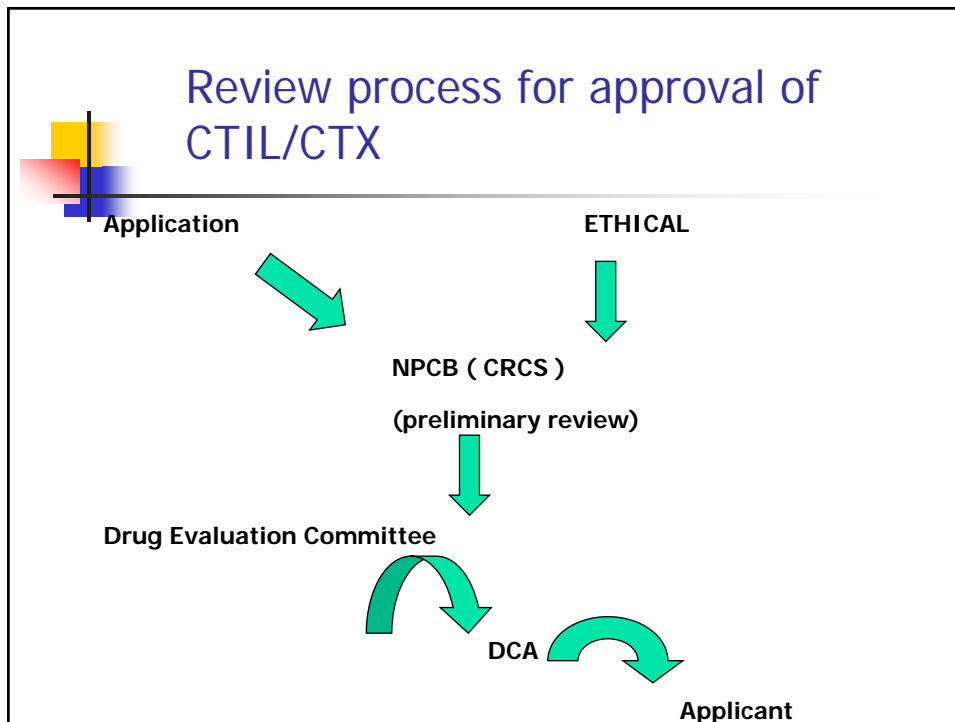

- ## Factors affecting speed of approval
- How complete is the information submitted?
  - How fast sponsor/ PI respond to queries ?
  - Adherence to established procedures
  - For CTIL and CTX - Ethical Approval given prior to release of CTIL/CTX



## Compliance

---

Who does inspections?

- By the local Regulatory Authority
- External Regulatory Authorities

Regulatory Inspection :

- GMP ( 'triggered'/'targeted' basis)
- GCP
- GLP



Thank You  
For Your Kind Attention

[www.bpfk.gov.my](http://www.bpfk.gov.my)



# Role of SFDA in Clinical trails Regulation in Saudi Arabia

*Abdulmohsen H. AL Rohaimi,*

*DDS, APC, MSc, Ph.D*

*Director of Research and Publication*

*March 17 – 21<sup>st</sup>, 2008*

*Review of drug development in clinical rails*

*Bangkok, Thailand*

*Pathumwan princess Hotel*

الهيئة العامة للغذاء والدواء  
Saudi Food & Drug Authority



SFDA

## *Disclaimer*

- *The information within this presentation is based on the presenter's expertise and experience, and represents the views of the presenter for the purposes of a training workshop*

الهيئة العامة للغذاء والدواء  
Saudi Food & Drug Authority



SFDA

# Saudi Food and Drug Authority (SFDA)

The SFDA : Recently established, 2004

## Vision

- To be the leading regional regulatory authority for food, drugs and medical devices with professional and excellent services that contributes to the protection and advancement of the health in Saudi Arabia.

## Mission

- To ensure the safety of food; the safety, quality and efficacy of drugs; and the safety and effectiveness of medical devices, by developing and enforcing an appropriate regulatory system.



## Regulatory framework

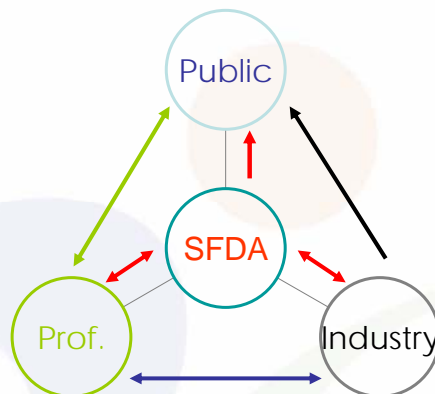

## Objective of my talk

- Give an insight into clinical trails in Saudi Arabia
- How are they Regulated
- What are the challenges facing SFDA in clinical regulations?
- Case study :clinical development and assessment of the marketing authorization application of biosimilar products



## Drug Process

- Phase I: first exposure in man, healthy volunteers, PK/PD studies
- Phase II: Early efficacy, dose ranging, short term safety/efficacy in patients.
- Phase III: Larger effectiveness studies, expanding safety knowledge, some are comparative
- Phase IV: Post marketing, additional safety information, other population groups, etc.





## New Drug Development

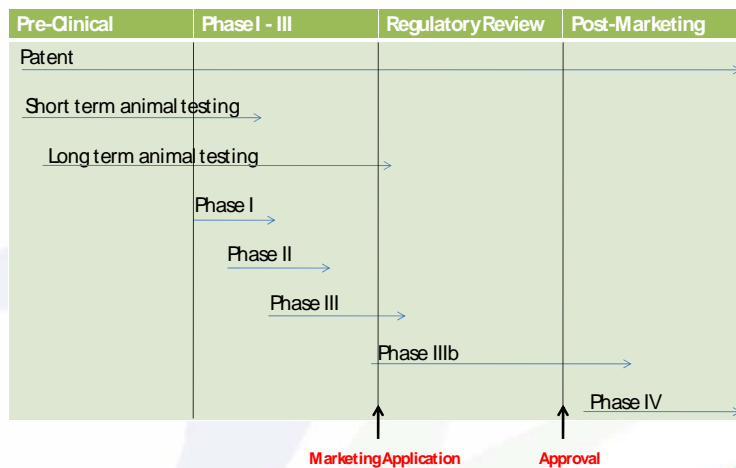

## Main Clinical Trails Requirements

Trial protocol

- Investigator Brochure & CV
- Subject Recruitment Procedure
- Consent forms
- Available safety Data for the IND
- Ethical Committee Approval
- Forms



## An insight of clinical trails in Saudi Arabia

- **Types of Clinical trials** : Most of Clinical Trials are :- Phase III
  - IIT ( Investigator Initiative Trial )

### Places of Clinical Trials In Saudi Arabia

- Tertiary Hospitals :e.g. King Faisal Specialist Hospital & Research Center
- King Abdulaziz City for Science & Technology

## An insight of clinical trails in Saudi Arabia

### Support :

Either self funded or with cooperation with pharmaceutical companies

## The Current Efforts for clinical trails regulation in Saudi Arabia

MOH : The Central Committee For Research Ethics

- **Governmental Hospitals** : Local Ethical committees- IRB

- **National committee For Research Ethics**

- informed consent : predictable side effects and risk
- protect research subject from unethical risk

Principle investigator responsibility: protocol ?

Payment of volunteers

## SFDA Guidelines

Protection of Trial Subjects Guidelines

- IRB, Investigator and sponsor responsibilities
- Manufacturing, Packaging, Labeling, and Coding of Investigational Product.
- Clinical Trial Protocol

## DIMENSION OF CHALLENGES

**ETHICS**

**SOCIAL**

**REGULATORY**

**PATENT PROTECTION**

## CHALLENGES IN RESEARCH

- TRANSLATIONAL RESEARCH
- POSTMARKETING SURVEILLANCE
- **CLINICAL IMPLICATION**
- ROLE OF HEALTH PROFESSIONAL
- LIABILITY ISSUES

## Regulatory Issues: Clinical Trails

- Approval of facility, commercial use
- Manufacturing methods
- Scale-up, need clinical equivalence, stability
- Purity, repeating units (peptides, DNA, RNA)
- Biological Generics

## Other Challenges

- Cost and duration ---revenue
- Lack of regulatory frame work
- Lack of clinical institute – GCP APPROVED

## Understanding the challenges and opportunity context

- Politics,
- Funding, - Research
- Interagency support,
- Competing organizations,
- Competing interests,
- Social and economic conditions,
- And history (of the program, agency, and past collaborations).

# Thank you



# Clinical Trials in Singapore

## Regulatory Framework



### Disclaimer

- *The information within this presentation is based on the presenter's expertise and experience, and represents the views of the presenter for the purposes of a training workshop*

## Presentation Outline

---

- Regulation of Clinical Trials
- Clinical Trials Statistics and Trends

## Presentation Outline

---

- Regulation of Clinical Trials
- Clinical Trials Statistics and Trends



## Vision



To be the **LEADING**  
**INNOVATIVE AUTHORITY**  
protecting and advancing **NATIONAL HEALTH** and **SAFETY**

## Mission

- To **wisely regulate** health products
- To **serve** the administration of justice
- To **secure** the nation's blood supply
- To **safeguard** public health



Health Products Regulation Group • Health Services Group • Applied Sciences Group

A Statutory Board of the Ministry of Health | The Singapore Public Service : Integrity • Service • Excellence

## Current Framework for Clinical Trials

- Parallel Submission to both IRB & HSA
- Ethics and regulatory approval timelines ~ 4-6 weeks
- The Health Sciences Authority issues the regulatory approval, in the form of a Clinical Trial Certificate
- CTC validity: 2 years and specific for each study protocol, each PI and site involved in the study
- The Licensing Authority for clinical trials under the Medicines Act is CEO HSA

## Supporting Documents for CTC

---

- Clinical Trial Protocol
- Investigator's Brochure
- Patient Information Sheet & Informed Consent Form
- Principal Investigator's CV
- GMP certificate / Certificate of Analysis

## Presentation Outline

---

- Regulation of Clinical Drug Trials
- Clinical Trials Statistics and Trends

## No of CT Applications & CTCs Issued

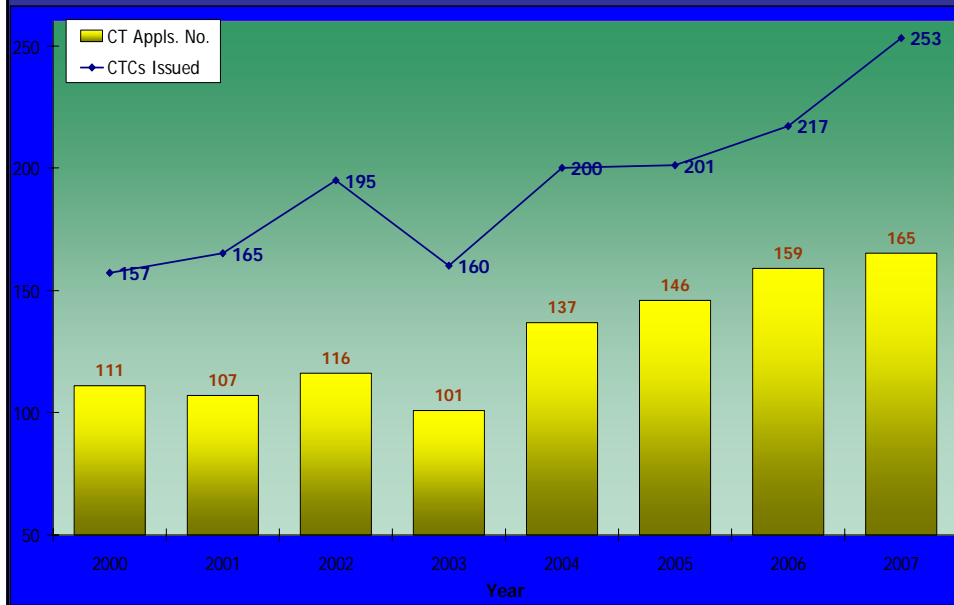

## Number of Clinical Trial Certificates

Phase	2000	2001	2002	2003	2004	2005	2006	2007
I	21	19	20	24	31	44	48	47
II	44	50	52	19	49	50	35	45
III	63	68	97	91	88	90	116	135
IV	29	28	26	26	32	17	18	26
	157	165	195	160	200	201	217	253

## Clinical Trials Therapeutic Areas (2007)

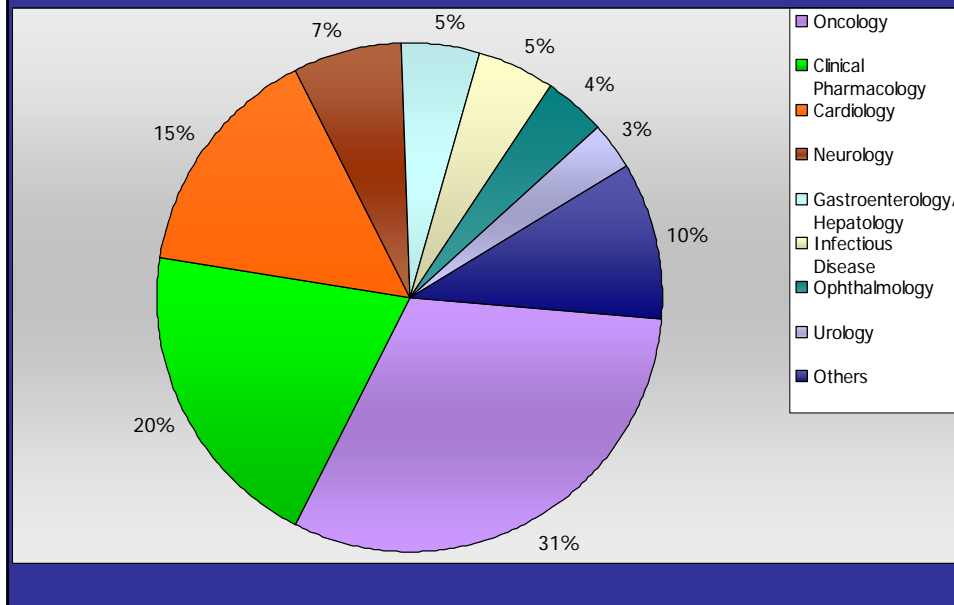

## Clinical Trial Trends

- Multinational or global trials sponsored by pharmaceutical companies/CROs: 70-80%
- Multinational or global trials (Phase II-III) to support NDAs to major regulatory agencies: 50-60%
- Progress in **Oncology** research especially in molecular targeted therapies: 25-30%
  - Advancement in genomics
  - Supported by cancer research centres focusing in early drug development, cancer pharmacology, cancer genetics & cancer endemic in Asia, as well as collaborations with the US National Cancer Institute
- Bridging studies are not required for local drug registration because of market size and difficulty in identifying a homogenous population
- Growing phase I **Clinical Pharmacology** studies: 20-25%

Thank you



Image courtesy of the Singapore Tourism Board



# Status of *Clinical Trial Environment* in Thailand

by

**Yuppadee JAVROONGRIT, Ph.D.**

Head of International Affairs and Investigational Drug Group

Drug Control Division, TFDA, MOPH, Thailand

Preliminary workshop: Review of Drug Development in Clinical Trials

Pathumwan Princess Hotel, Bangkok, Thailand

17-21 March 2008

Preliminary WS: Review of Drug Dev. in CT



## Disclaimer

- *The information within this presentation is based on the presenter's expertise and experience, and represents the views of the presenter for the purposes of a training workshop*

Preliminary WS: Review of Drug Dev. in CT



## Outline:

- **Sponsor & CRO**
- **Investigator**
- **Ethical Committee (EC)**
- **Regulation**
- **Others**

Preliminary WS: Review of Drug Dev. in CT



## Sponsor & CRO

- **Current Sponsors ( for 291 trials -as of 27 Aug 07)**
  - major are MNCs (63%)
  - also others (University/Organization 25%, NIH 8%, and other Federal Agency 4%)
- **CRO**
  - domestic CRO (Medica Innova,..)
  - normal CRO (Apex, Covance, Quintites)
  - Institute-CRO networking (Aclires, Apec-IATEC)
- **Trend & Plan :-**
  - **provide Training**
  - **internal Auditing**
  - **enhance Successful in competitive enrollment**
  - **imported Tax**

Preliminary WS: Review of Drug Dev. in CT





TFDA

## Investigator

- **experienced** (in Pharmaceutical, and Biological Trials)
  - various Phases :- *I, II, III, and IV*
  - Vaccines
  - various area :- Cancer, Cardiovascular, D.M., Hepatitis, HIV/AIDs, Infectious & Topical diseases, Accidental Injury/Trauma)
- **Networking**
  - CRCN (Clinical Research Collaboration Network)
  - HIV-NAT (The Thai Red Cross AIDS Research Center)
- **Trend & Plan :-**
  - **to increase in a Numbers**
  - **to improve Quality & Speed of the Trial**
  - **to work in New highly technology (i.e. Snip,**
  - **enhancing the contribution to the R&D**

Preliminary WS: Review of Drug Dev. in CT



TFDA

## Ethical Committee

- **Current ECs** ( ~ 20 ECs)
  - Types:- *government, academic, private*
  - Joint Research Ethics Committee (JREC)
- **Standards**
  - International Std. (CIOMS, ICH-GCP, Declaration of Helsinki, WHO)
  - Strengthening Members (Training, and Study Visit-WIRB)
- **Networking :-**
  - FERCIT – *Forum of Ethical Review Committees in Thailand*
  - FERCAP – *Forum of Ethical Review Committee in the Asian & Western Pacific Region*
- **Trend & Plan :-**
  - **SIDCER / FERCAP audit-recognition programme**
  - **OHRP/FWA Registration**
  - **acceptant by the TFDA**
  - **competitive Timeline**

Preliminary WS: Review of Drug Dev. in CT







# Regulation by TFDA

## Current

- **sequence Application, after EC Approval**
- **need :-**
  - Drug label
  - Drug leaflet
  - CFS (or EC Approval)
  - Clinical Trial Report
  - Clinical Trial Protocol
- **Requirement :-voluntary**
  - GCP
  - Report of “Unexpected-SADR”
- **Scientific Review/Assessment**
  - partial & initiative step
- **Accepted ECs**
  - design by Sub-National Drug Committee
  - total of 9 ECs
- **GCP Inspection :- N/A**

## New

- **might allow “Parallel Application”**
- **need :-**
  - Drug label
  - Drug leaflet (for registered Drug)
  - Investigator Brochure
  - Patient Information Sheet (in Thai)
  - Clinical Trial Protocol
  - Info. on Drug Quality & GMP
- **Requirement :-mandatory**
  - GCP
  - GMP
  - Report of “Unexpected-SADR”
- **Scientific Review/Assessment**
  - Systemic & Fully implement
- **Accepted ECs**
  - formal System
  - coop. with SIDCER/FERCAP
- **GCP Inspection :- formal System**
- **IND→ NDA**

Preliminary WS: Review of Drug Dev. in CT



# Others

## Infrastructure

- pop. ~ 65 mill.
- Med.Hospital Faculty =12
- Health Professional Resources ;
  - ~ 29,000 Physician
  - ~ 8,000 Dentist
  - ~ 18,000 Pharmacist
  - ~ 153,000 Nurse

## ICRCC

### (International Clinical Research Collaboration Center)

- **Members:**
  - CRCN
  - PReMA
  - TCELS
  - TDRI
- **Activites:**
  - info. exchange
  - management team
  - research collaboration & services
  - Quality system
  - network to all Stakeholder
- **Outcome :**
  - Clinical Research Center

## SIDCER

### (The Strategic Initiative for Developing Capacity in Ethical Review)

- **Primary Objective:**
  - to contribute to human subject protections globally by developing capacity in ethical review and the ethics of health research.
- **Activites:**
  - survey
  - training
- **Cooperation with TFDA :**
  - Acceptance EC's List
  - Capacity building

## Situation

- GCP adopted in 2000
- ~ 6,000 trainees on GCP(y.2002-7)
- active and closely cooperation
- regular Annual Seminar
- willing & ready for participate - “Global Drug Development”

Preliminary WS: Review of Drug Dev. in CT



# Thank You

# ขอบคุณค่ะ

Preliminary WS: Review of Drug Dev. in CT



## Investigator (2)



- Consortium of Thai Medicine Schools
- Healthy Systems Research Institute
- Office of the National Research Council of Thailand
- Thai Health Organization of Thailand
- Thailand Center of Excellence for Life Sciences



Preliminary WS: Review of Drug Dev. in CT

**Ref: Dr.Pyatat TATSNAIVAT**



## Changing – Networking (1)

### CRCN

#### The Consortium of Thai Medical Schools

- **Members:** *all medical schools (16)*
- **CRCN:** *the only research network of the consortium*
- *over 12,000 beds*
- *with > 18,000 beds (Regional Hospital, MOPH)*
- *All clinical specialties*
- *Many (over 200) with Clinical Epidemiology training*
- *Qualified Laboratories*
- *Clinical Trial Centers-networking*
- *Virtually 1 Policy-making body*
- *Shared resources-profits*

Preliminary WS: Review of Drug Dev. in CT

Ref: Dr.Pyatat TATSNAIVAT



### ICRCC

#### International Clinical Research Collaboration Center



Preliminary WS: Review of Drug Dev. in CT

Ref: Dr.Pyatat TATSNAIVAT



## ICRCC

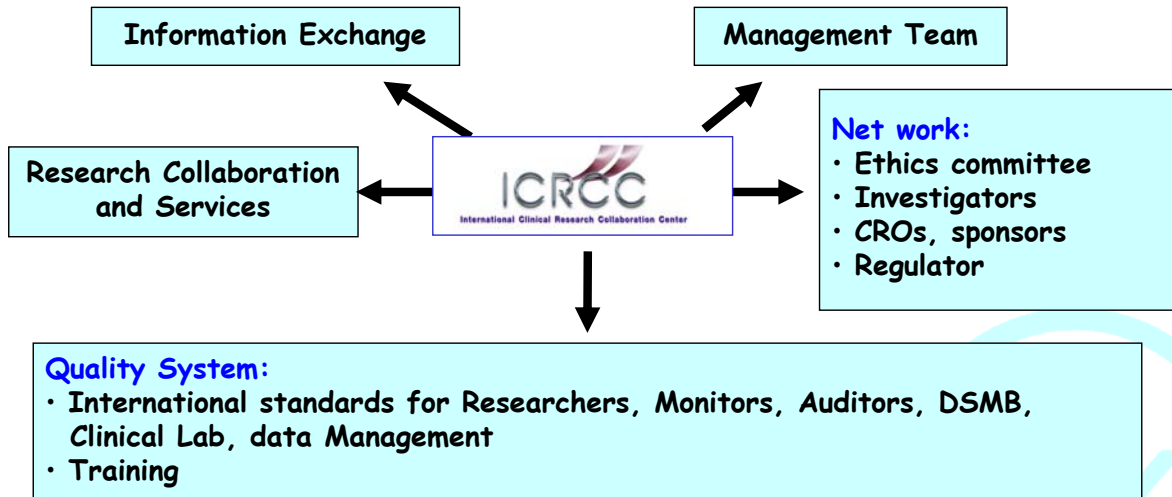

Preliminary WS: Review of Drug Dev. in CT

Ref: Dr.Pyatat TATSNAIVAT



## The Overall Plan on Changing

- new Roadmap
- Pharmacogenetics
- Clinical Research Center
- IND Trial
- IND → NDA
- Strengthening & Networking “Stakeholder”

**→ Healthy & Powerful Clinical Research in Thailand**

Preliminary WS: Review of Drug Dev. in CT

# **Introduction to clinical trials on medicinal products in Vietnam**

*Do Minh Hung  
Drug Administration  
of Vietnam*

*Bangkok, Thailand-  
17th March 2008*

## **Disclaimer**

- *The information within this presentation is based on the presenter's expertise and experience, and represents the views of the presenter for the purposes of a training workshop*

## **Current Vietnamese Legislation**

- 1. Drug Acts, 2005.**
- 2. Regulation of Clinical Trials, 2007.**
- 3. Regulation on drug registration, 2001.**
- 4. Organization:**
  - **Ministry of Health (MOH).**
  - **Department of Training & Sciences(DTS)**
  - **Ethics Committee.**
  - **Clinical Trials site.**

## **Elements included in Regulations**

(1 of 2)

- **The establishment, regulation and supervision of Ethics Committees;**
- **The procedure for obtaining an Ethics Committee opinion; & for Clinical Trial Authorization (CTA)**
- **Requirements to comply with the conditions and principles of good clinical practice (GCP);**
- **Obligations in respect of the reporting of the various adverse events encountered in subjects participating in trials, including the recording, reporting and notifying of such events;**

## **Elements included in Regulations**

(2 of 2)

- **Controls over the supply of investigational medicinal products;**
- **Requirements for the labelling of investigational medicinal products;**
- **Provisions relating to offences, penalties and enforcement.**

## **Requirement of a Clinical Trial**

(in Regulations) 1/2

- **All interventional clinical trials involving medicinal products are subject to control (no exemptions);**
- **A sponsor must make arrangements for the conduct of a clinical trial;**
- **All trials must be authorised by the MOH prior to commencement;**
- **Legal basis created for implementation of the principles of GCP (wherever the trial is conducted);**
- **A favourable Ethics Committee opinion must be available for all trials;**

## **Requirement of a Clinical Trial** (in Regulations) 2/2

- **Legal authority is being created to inspect trial sites, including those at hospitals and universities;**
- **Manufacture of investigational medicinal products (including placebos and active comparators) to be carried out by licensed manufacturers under GMP conditions;**
- **Investigational medicinal products to be supplied free by the sponsors.**

## **Regulatory challenges: inspections of clinical trials**

- **The Capacities of MOH in management of Clinical Trial (new field in Vietnam)**
- **The performance of GCP inspections (lack of resource)**
- **The condition of Clinical Trial Site (few and weak).**



## **Type of Clinical Trials**

1. **When developing a new medication, the process starts in test tube and animal studies (Pre-Clinical).**
2. **The Stages of CTs:**
  - **Phase I: In < 80 Healthy volunteers, few weeks to few months length.**
  - **Phase II: About one hundred participants, about a year length.**
  - **Phase III: At least several hundred participants, may last for two years to three years. A medication can be approved by FDA.**
  - **Phase IV: If a medication is approved, the drug company may conduct phase IV for long-term safety information; About thousands participants.**
3. **The Volume of CT in Vietnam (From the regulation came into force in 1/2007): 2 CTs have been conducted in 2007 (New vaccine).**

## **Prepare essential documents before the trial can commence**

- **Consent Form**
- **Patient Information Leaflet (PIL)**
- **Writing the protocol**
- **Confirm that the investigational medicinal product (IMP) is produced in compliance with Good Manufacturing Practices (GMP).**
- **Identify sponsor**
- **Agreement between Sponsor and CI/PI**

## **Obtain Approvals**

- 1. Ethics Approval** : An ethics committee has issued a favourable opinion in relation to the clinical trial;
- 2. The MOH has granted an authorisation in respect of the clinical trial; and**
- 3. The sponsor of the trial, or the person authorised to act on his behalf, is established in the Community.**

## **Conduct the trial in accordance with GCP and GMP**

- Essential Documents during the conduct of the clinical trial**
- Amendment to the trial**
- Extensions to existing trials that have rolled over**
- Reporting adverse reactions**
- Annual reports**

## **The ends of CTs**

- **Declaration of the end of the study**
- **Submit Final reports**
- **Ensure essential documents are maintained and archived**

**Thank You!**



## 1.2 - Overview of Regulation of Clinical Trials in Canada

Presentation to APEC Preliminary Workshop  
on Review of Drug Development  
in Clinical Trials

**Celia Lourenco, PhD,**  
Manager, Clinical Group I  
Office of Clinical Trials  
Therapeutic Products Directorate

*Disclaimer: the information within  
this presentation is based on the  
presenter's expertise and  
experience, and represents the  
views of the presenter for the  
purposes of a training workshop*

## Objectives

Regulations & guidelines  
Number of Clinical Trial Applications  
Current initiatives

## Regulatory Framework

**Food and Drugs Act**  
Definition of Drug and types of drugs  
Inspection authority

**Food and Drug Regulations**  
Part C: Drugs

Other Regulations...

**Division 5:**  
Drugs for Clinical  
Trials Involving Human  
Subjects



## Clinical Trial Regulations for Drugs

- Regulations prior to September 1<sup>st</sup>, 2001, were:
  - the IND regulations implemented in the early 60's
  - under Division 8 of Part C of the Food and Drug Regulations
- Current regulations under Division 5 have been in effect since September 1<sup>st</sup>, 2001, and were implemented with two overarching objectives:
  - strengthen protections for human research subjects
  - increase R & D investment in clinical trials in Canada

5

## A regulatory framework that...

- Incorporates essential elements of Good Clinical Practices
  - Sound research protocol
  - Informed consent of research subjects
  - Obtain REB approval and continuing oversight
  - Appropriate qualifications of investigator and staff
  - Monitor and report serious, unexpected, adverse drug reactions
  - Maintain accurate records
- Gives the Minister clear authority to reject, suspend or cancel the authorization of a clinical trial

6

## Guidelines adopted by Health Canada

- ICH
  - Quality: Q1A(R2), Q1B, Q1C, Q1D, Q1E, Q1F, Q2A, Q2B, Q3A(R), Q3B(R), Q3C, Q5A, Q5B, Q5C, Q5D, Q6B, Q7A
  - Multidisciplinary: M3, M4
  - Safety: S1A, S1B, S1C, S1C(R), S2A, S2B, S3A, S3B, S4A, S5A, S6, S7A, S7B, Health Canada Q & A document for S7B and E14
  - Efficacy: E1, E2A, E3, E4, E5, E6, E7, E8, E9, E11, Health Canada Addendum to E11, E14

7

## Guidance documents developed by Health Canada

- Standards for clinical trials in type 2 diabetes in Canada
- Clinical Trial Applications
- Clinical Trial Applications for comparative bioavailability studies for pharmaceuticals
- Quality (chemistry and manufacturing) guidance for pharmaceuticals, biologics, and radiopharmaceuticals
- Inclusion of women in clinical trials
- Requirements for tuberculosis screening
- Submission of pharmacogenomic information

## Clinical Trials Regulated (1)

- Trials subject to a clinical trial application (CTA):
  - Phase I, II, and III trials
  - Includes trials investigating off-label uses
  - Independent of type of sponsor

9

## Clinical Trials Regulated (2)

- Phase IV trials (investigations on-label):
  - exempted from CTA filing
  - REB approval required
  - GCPs must be observed
  - record-keeping required

10



## Regulatory Requirements

- Legal accountability lies with the sponsor
- Clinical Trial Application (CTA) and CTA-amendment
- 30 calendar day review period with 2-day turnaround for requests for additional information
  - No-Objection-Letter (NOL)
  - Not-Satisfactory Notice (NSN)
- Post authorization requirements, including reporting of serious, unexpected adverse drug reactions
- Clinical trial site inspection program

11

## Overview of CTA Process

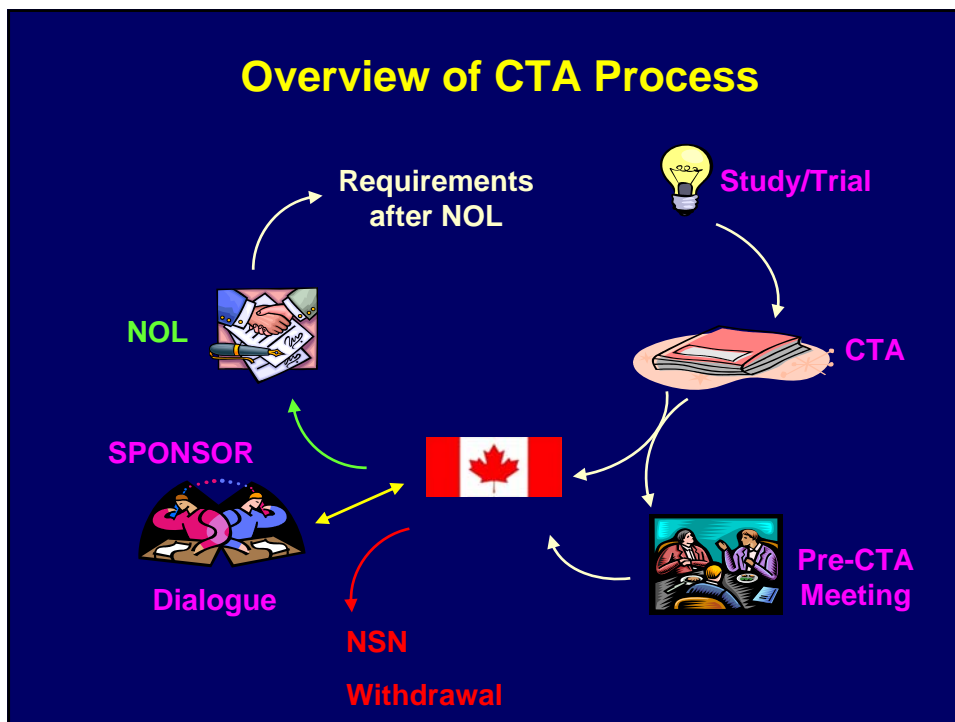

## Format of a CTA

- **Module 1**
  - Administrative information
  - Clinical
- **Module 2**
  - Chemistry and manufacturing templates
- **Module 3**
  - Supporting chemistry and manufacturing information

13

## Content of a CTA

- Covering letter
- HC/SC form 3011
  - ✓ Attestation
- Protocol and Informed Consent Form
- Investigator's Brochure or Product Monograph
- PSEAT
- Clinical trial site information form (CTSI)
- REB refusals
- Letter of authorization to cross-reference information filed by a different sponsor
- Module 2 and 3 with chemistry & manufacturing

## CTA Review by Health Canada

- The reviewers assess all the information provided by the sponsor, including:
  - Scientific merit: rationale, study design, patient population, dosage regimen, safety and efficacy variables
  - Sufficient information to support the safety of the drug for the purposes of the clinical trial
  - Adequate communication of potential risks and anticipated benefits to clinical trial subjects
  - Acceptable chemistry and manufacturing information
- Other sources of information:
  - ICH guidelines
  - Current clinical practice guidelines
  - Published literature & information
  - Expert opinion (e.g., consultation with other HC bureaus, scientific advisory committees)

15

## Requirements after NOL

- Clinical Trial Site Information form and REB approval
- Serious, Unexpected, Adverse Drug Reaction Reporting
- Changes to the protocol or quality information (amendments and notifications)
- Premature discontinuation of a trial
- Research Ethics Board refusals
- Lot release information provided through fax-back form (for Biologics)
- Records retention

16

## CTA-Amendments

- A *CTA-amendment* is required for changes to the protocol that:
  - affect the selection, monitoring or dismissal of a clinical trial subject
  - affect the evaluation of the clinical efficacy of the drug
  - alter the risk to the health of a clinical trial subject
  - affect the safety evaluation of the drug
  - extend the duration of the clinical trial
- Changes to the chemistry and manufacturing that may affect the safety or quality of the drug
- If clinical trial endangers the health of a clinical trial subject or other person, may implement an amendment immediately and file the *CTA-amendment* within 15 days

17

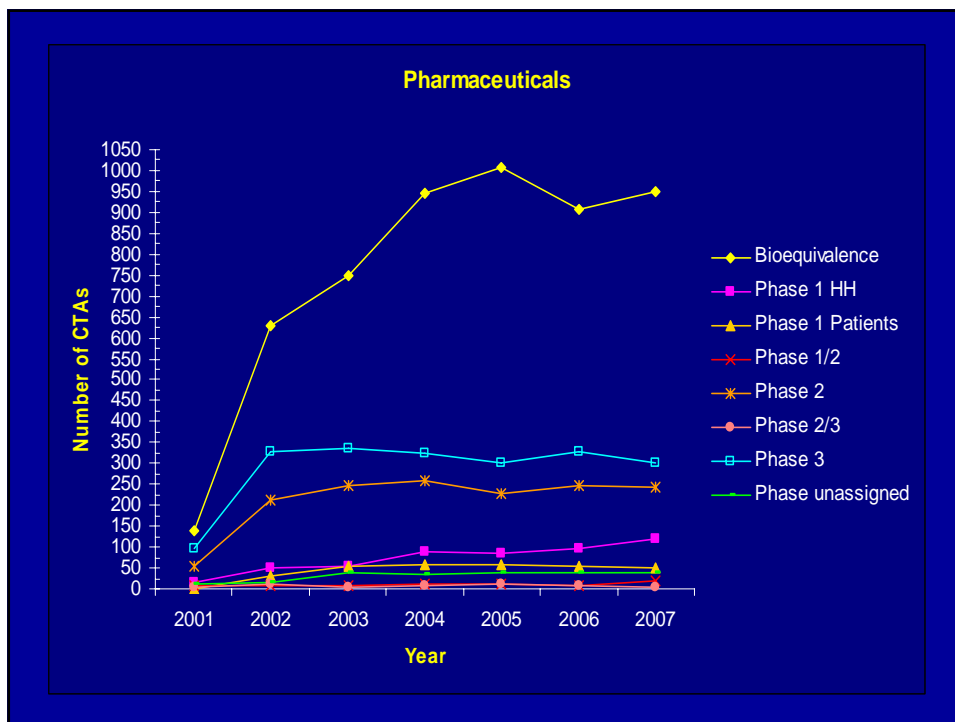

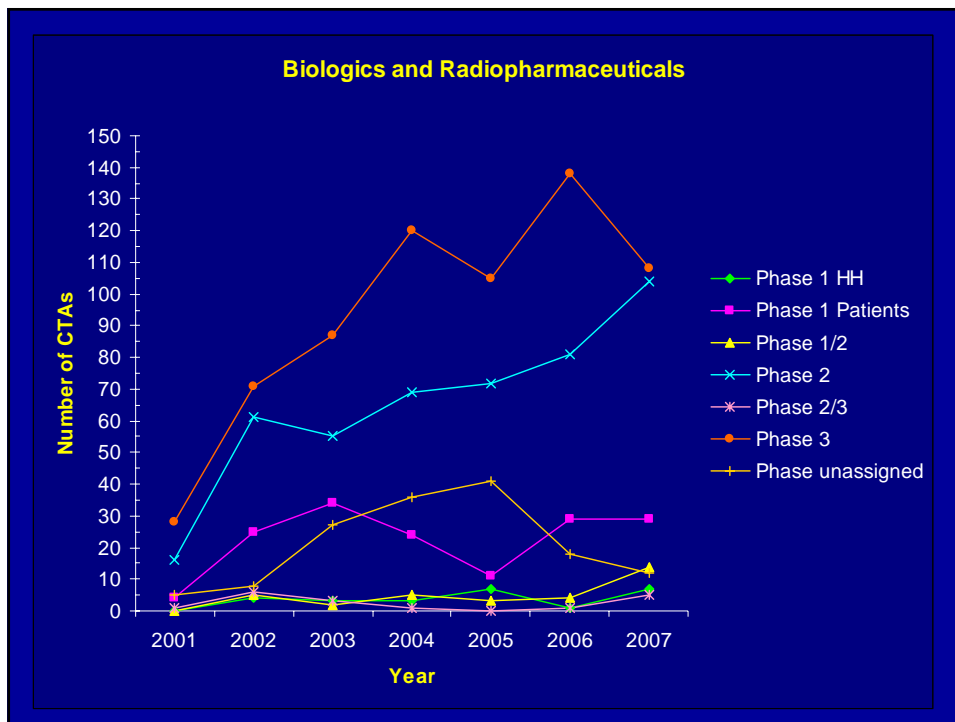

Therapeutic Products Directorate
Direction des produits thérapeutiques

## Ongoing Initiatives

- Review of the regulatory framework supported by Division 5
- Implementation of Canada Vigilance System for the management of ADRs
- Research Ethics: development of voluntary standards for REBs
- Clinical Trials Registration and Disclosure

20

## Summary

- Clinical trials regulated under a legal framework incorporating GCPs
- CTA required for Phase I, II, III
- 30 calendar day review period with 2 day turnaround for requests for additional information
- Ongoing requirements after authorization
- Clinical trial inspection program
- ICH guidelines and HC guidance documents
- Number of CTAs have increased since 2001, but stable since 2004
- Ongoing HC initiatives impacting on clinical trials

21

## References

Division 5 Regulations	<a href="http://www.hc-sc.gc.ca/dhp-mps/alt_formats/hpfb-dgpsa/pdf/compli-conform/1024_e.pdf">http://www.hc-sc.gc.ca/dhp-mps/alt_formats/hpfb-dgpsa/pdf/compli-conform/1024_e.pdf</a>
Clinical Trials e-Manual	<a href="http://www.hc-sc.gc.ca/dhp-mps/prodpharma/applic-demande/guide-ld/clin/cta_intro_e.html">http://www.hc-sc.gc.ca/dhp-mps/prodpharma/applic-demande/guide-ld/clin/cta_intro_e.html</a>
Review of the Regulatory Framework for Clinical Trials	<a href="http://www.hc-sc.gc.ca/dhp-mps/prodpharma/activit/consultation/clin-rev-exam/index_e.html">http://www.hc-sc.gc.ca/dhp-mps/prodpharma/activit/consultation/clin-rev-exam/index_e.html</a>
Registration and Disclosure of Clinical Trial Information	<a href="http://www.hc-sc.gc.ca/dhp-mps/prodpharma/activit/proj/enreg-clini-info/index_e.html">http://www.hc-sc.gc.ca/dhp-mps/prodpharma/activit/proj/enreg-clini-info/index_e.html</a>
Other/Relevant Information related to Clinical Trials	<a href="http://www.hc-sc.gc.ca/dhp-mps/prodpharma/applic-demande/guide-ld/clin/index_e.html">http://www.hc-sc.gc.ca/dhp-mps/prodpharma/applic-demande/guide-ld/clin/index_e.html</a> <a href="http://www.hc-sc.gc.ca/dhp-mps/prodpharma/applic-demande/guide-ld/qtqtc/index_e.html">http://www.hc-sc.gc.ca/dhp-mps/prodpharma/applic-demande/guide-ld/qtqtc/index_e.html</a>

# PMDA and Application Procedures

Pharmaceuticals and Medical Devices Agency  
(PMDA)

Junko Sato



## Disclaimer

- *The information within this presentation is based on the presenter's expertise and experience, and represents the views of the presenter for the purposes of a training workshop*



# WHAT 'S



## Our Agency

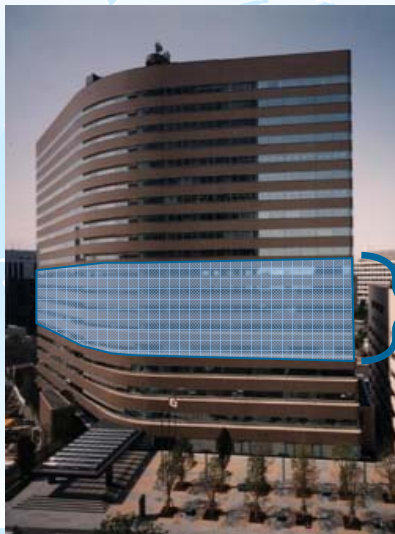

PMDA Office

6th – 11th Floor  
(Reception : 6th Floor)

Shin-Kasumigaseki Bldg.  
3-3-2, Kasumigaseki, Chiyodaku,  
Tokyo 100-0013 JAPAN





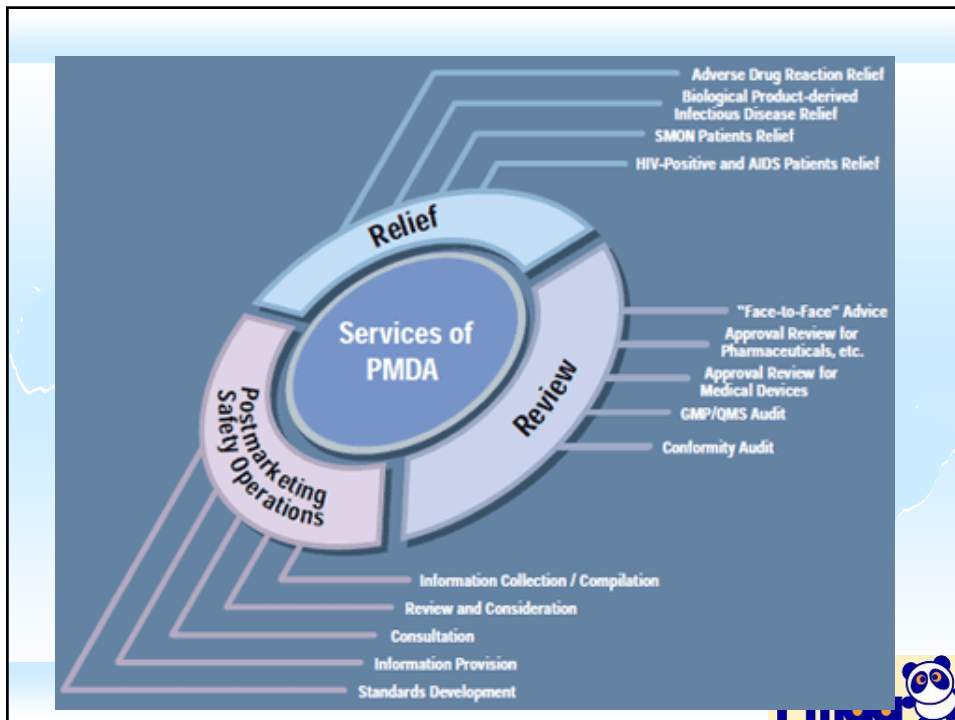
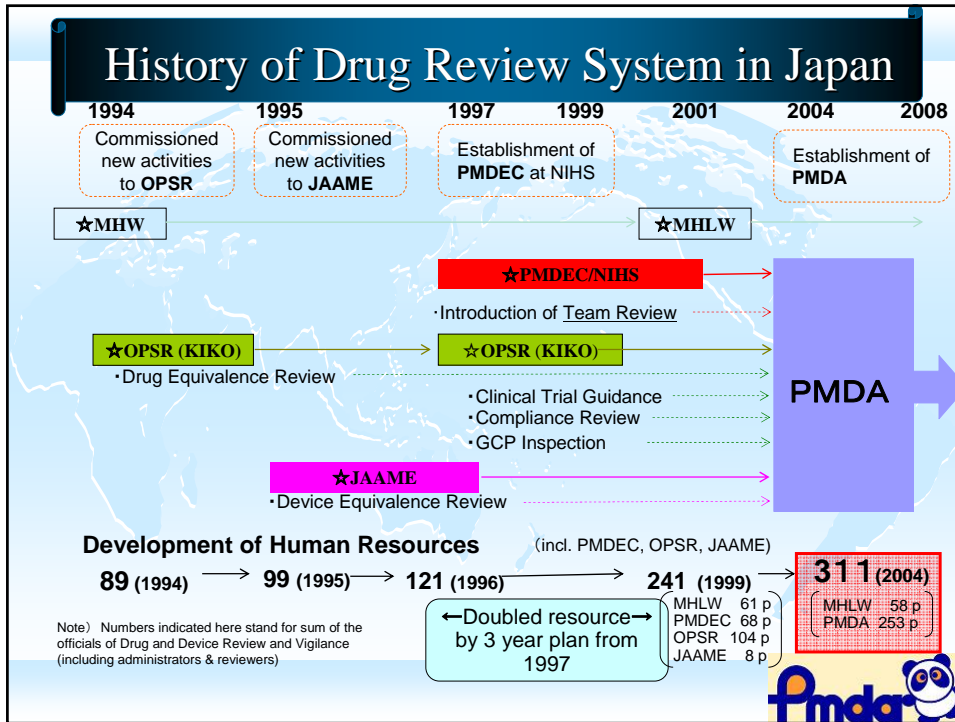

# Drug Development in Japan

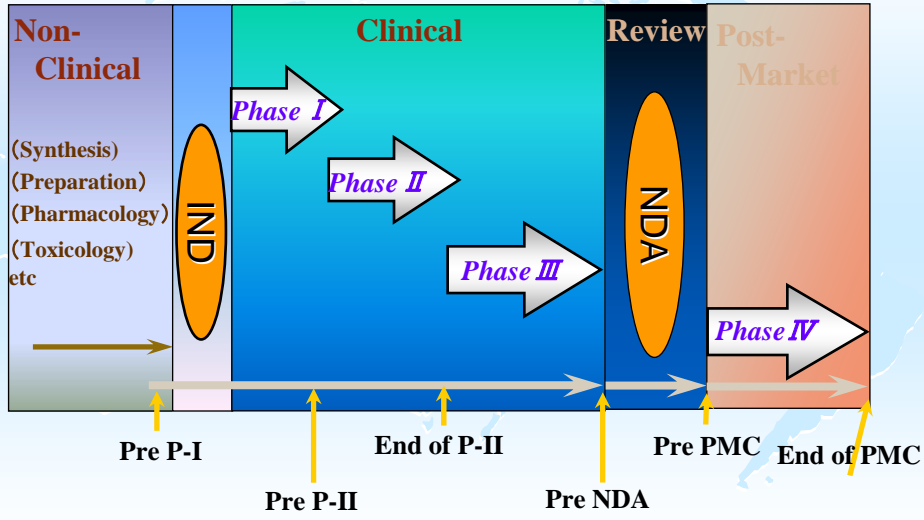

Many chances to discuss with PMDA



# Numbers of PMDA consultations

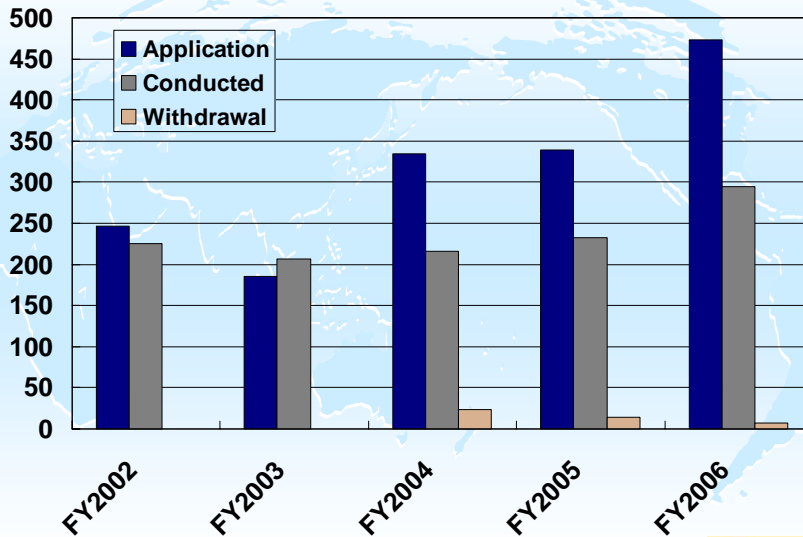

- From this April, **New IND Scientific Consultation Process** will be started
  - Increase numbers of meeting to meet a demand by sponsors
  - Meeting in more timely manner

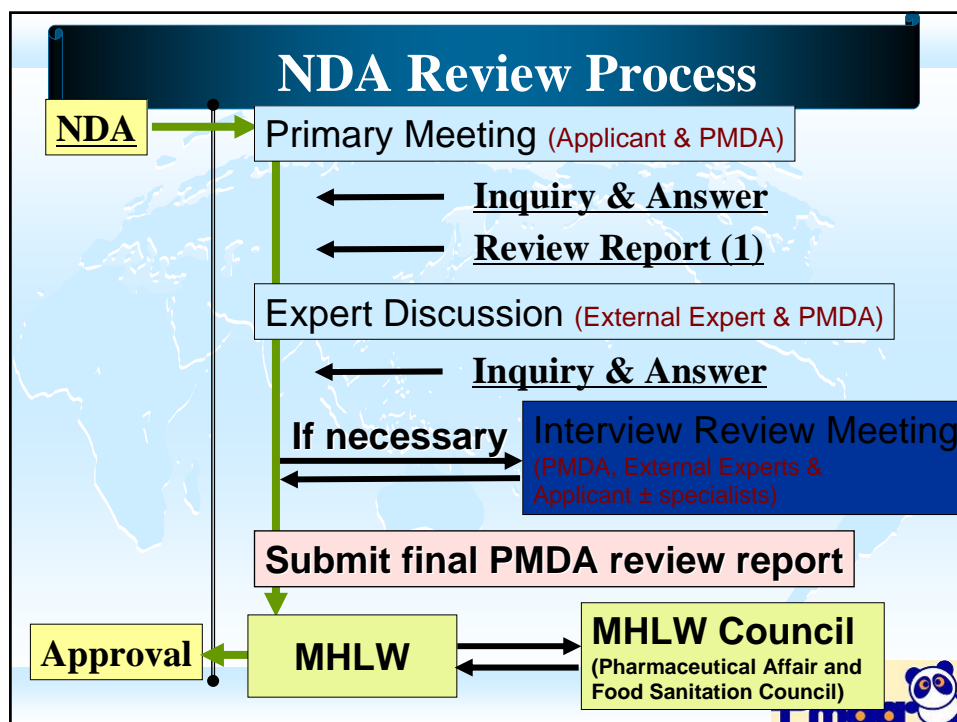

Thank you for your attention.



<http://www.pmda.go.jp/>





**APEC Preliminary Workshop: Review of Drug Development in Clinical Trials**

Session 1.4 -Clinical Trial Environment  
United States (FDA) and European Union (EMA)

Susan D'Amico  
Vice President and Global Head  
Clinical Quality Assurance

 **NOVARTIS**

© 2008 Novartis

## Disclaimer

- *The information within this presentation is based on the presenter's expertise and experience, and represents the views of the presenter for the purposes of a training workshop*

# U.S. Food and Drug Administration

## FDA's Mission Statement

The FDA is responsible for protecting the public health by assuring the safety, efficacy, and security of human and veterinary drugs, biological products, medical devices, our nation's food supply, cosmetics, and products that emit radiation. The FDA is also responsible for advancing the public health by helping to speed innovations that make medicines and foods more effective, safer, and more affordable; and helping the public get the accurate, science-based information they need to use medicines and foods to improve their health.



## Department of Health and Human Services Food and Drug Administration

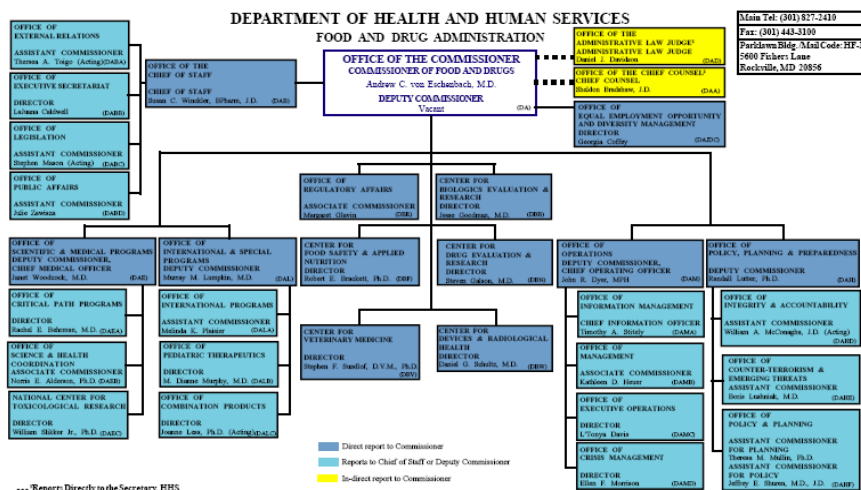

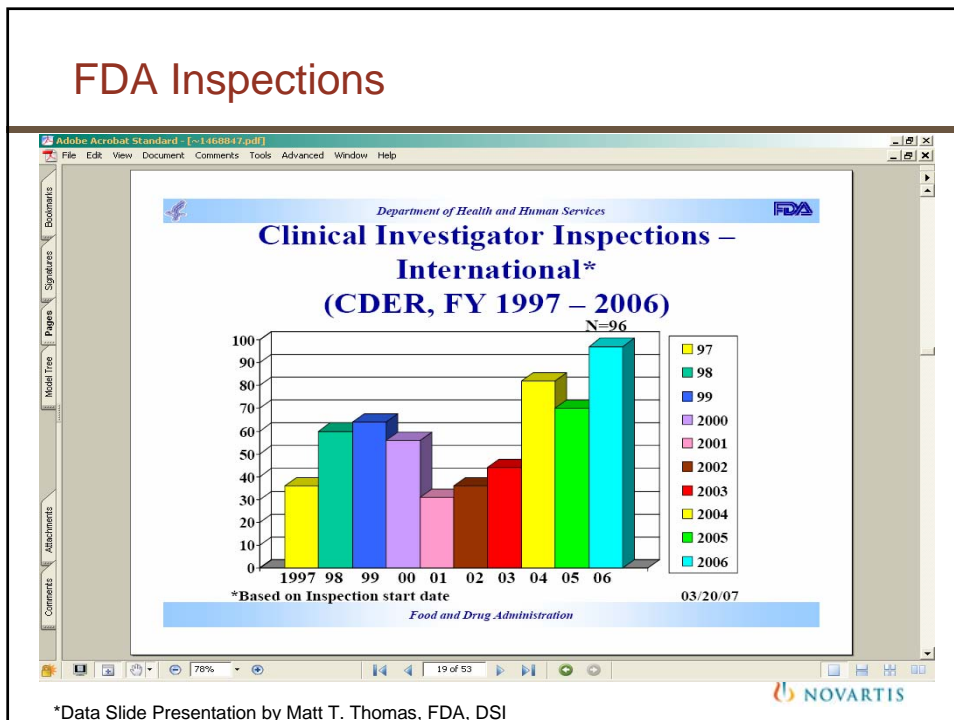
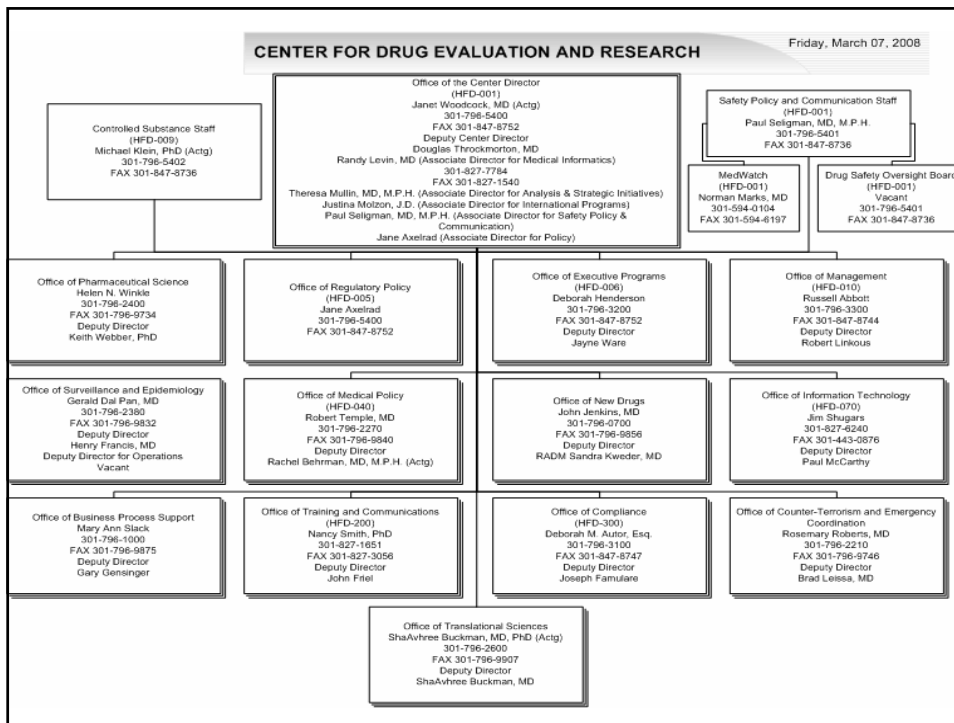

# FDA Inspection Results

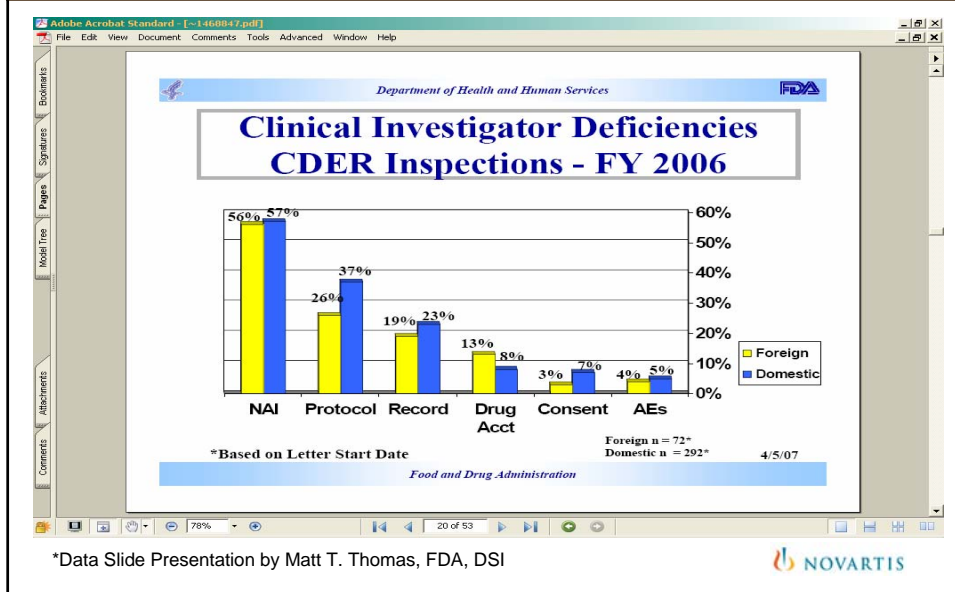

# European Medicines Agency -Structure

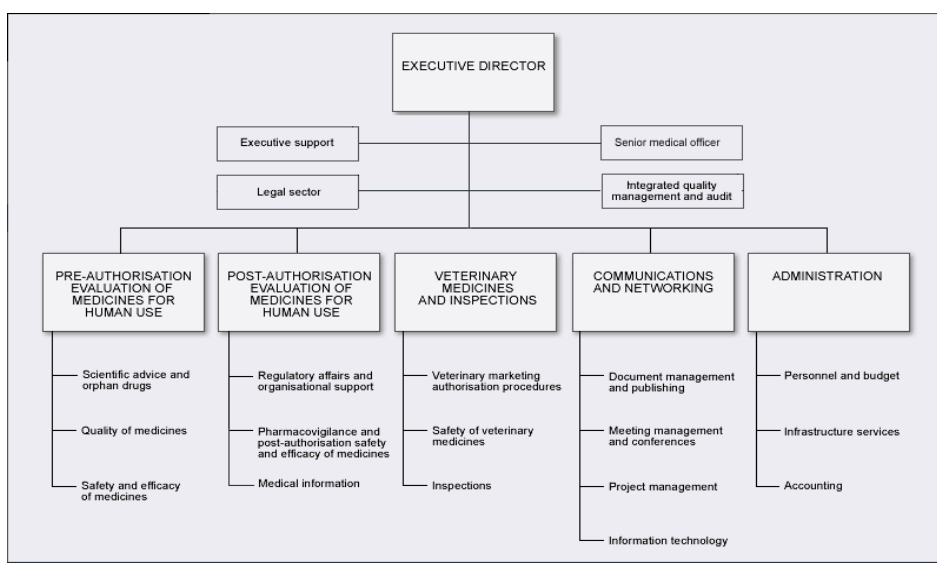



## European Medicines Agency

### Mission statement

The mission of the European Medicines Agency is to foster scientific excellence in the evaluation and supervision of medicines, for the benefit of public and animal health.

### Legal role

- The European Medicines Agency is the European Union body responsible for coordinating the existing scientific resources put at its disposal by Member States for the evaluation, supervision and pharmacovigilance of medicinal products.
- The Agency provides the Member States and the institutions of the EU the best-possible scientific advice on any question relating to the evaluation of the quality, safety and efficacy of medicinal products for human or veterinary use referred to it in accordance with the provisions of EU legislation relating to medicinal products



## HA Environment for Clinical Trials:

Who are the players?

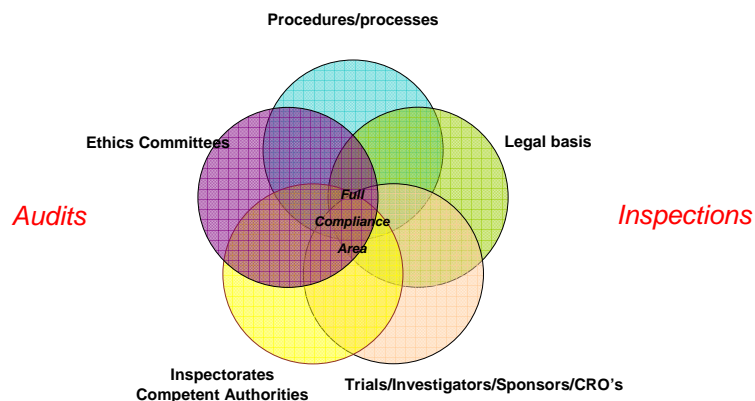

## What is Risk Perspective for HA?

*For whom?*

### *Trial subjects*

- May place subjects in that trial at possible **safety risk**
- May place future trial subjects at **risk**

### *Patients*

- May place future patients or consumers at **risk**
- May **delay availability** of medicines

### *Products*

- May place product(s) at quality/safety/efficacy **risk**
- **Undermines** business, availability of medicines

### *Health Authority*

- Jeopardizes the **reliability** of submitted and/or published data
- **Undermines the HA** ability to protect and promote the public health
- **Undermines trust** of public in company/pharma industry



## HA Requirements:

*Legalities*

### *Legal basis is essential:*

- Rights (protection and access)
- Requirements, standards (minimum, definite)
- Sanctions (professional, bureaucratic, punitive)
- Qualifications, processes and procedures

### *Types of legislation:*

- National legislation
- EU legislation: Rules, regulations, directives, guidances, guidelines
- Third Country
- Professional standards

### *International complexities:*

- Rights, requirements, sanctions, legislation differences, teams



## HA Requirements:

### *Responsibilities*

#### *Sponsor/applicant:*

Development process, Conduct clinical trials  
Composition and content of dossier  
Completeness of application dossier

#### *Investigator*

Safety of subjects, quality of data,

#### *Authorities*

Legal basis  
Assessment of dossier: verification of quality, safety and completeness of dossier, inspections of clinical trials and monitoring of Pharmacovigilance  
Licenses (manufacturing, marketing)



## Inspection Practices

### *General Approach in EU*

*EMA coordinates processes and procedures for CAP*

For decentralized/local inspections in MS: many similarities  
Joint inspections versus single MS

*What is inspected:*

“ All that is deemed necessary by HA/Inspectors ”  
= Re(Leg)ality

Inspectorates choices (annual plan, risk analysis, fashion)

MEB/CHMP choices

EMA/CHMP

For cause, calamity, complaint



## Inspection Practices

### *Conduct*

---

#### *Inspection format:*

- System directed, company (sponsor) and/or facility (site) directed
- Study/project directed
- Product directed (novel, generic, ...)
- Cause directed
- Ethics committees, safety committees
- For cause, routine, thematic

#### *Inspection activities (external):*

- Systems verification
- Data verification
- Educational activities



## Inspection Practices

### *When and How?*

---

#### *Inspection timing:*

- Pre-, post approval
- Obligations
- Before, during, after trial

#### *Inspection process:*

- Planning, preparing, **conducting**, reporting, follow up

#### *Inspection strategies:*

- Review, interview, access, test, re-analyze, recalculate
- Follow the process
- Evaluation

#### *EU Inspection frequency:*

- EMA goal 15-30/annum (Sponsor/application/PhV)



## Foremost EU Findings

*All Clinical trial and safety areas implicated*

### *Patient safety, efficacy and data quality:*

- EC approval, insurance, privacy (legal aspects/MS/third countries)
- IB, GLP (updates, present, IMPD)
- Protocol deviations (short cuts, trial vs. regular treatment)
- Contracts
- Responsibilities, work load (QP, QA, investigator, monitors)
- SAE/ADR reporting (CA, EC, Investigator)
- Information communication
- E-systems validation (awareness of users, new, archiving)
- No full Q-system (both GCP and PV )coverage (sponsor global vs. local vs. CRO vs. site)
- Monitoring (training, planning, activities, follow up)
- IMP aspects (manufacturing, blinding, distribution, IVRS, accountability)
- Sources (definition, systems, documentation, filing, archiving)
  - SDV inconsistencies (sloppiness, misconduct, fraud)
- Fraud and misconduct
  - (Directly detected fraud in NL inspections: 4 in 2006)



## High Level Root Cause:

*Conclusion From Inspection Findings*

### Common denominator: Sponsor

- Preparation for trial
- **Timelines**
- **Grip** on trial and participants
- Definition of responsibilities and terms
- **Investigator** versus “name”
- Evaluation of participants
- **Processes and procedures**



## Use of Inspection Results

*As part of the entire evaluation process; adds/completes information*

- Clinical assessment and inspection are two different aspects of verification of compliance and safety
- Inspection contributes to the verification of the quality of the data in the dossier
- Inspection will not enhance quality of data and dossier but enhance certainty on the quality
- There may be consequences for other notifications/ applications/authorisations (positive/negative)



## If Not.....

**What will happen in the event of observed non-compliance:**

- Education, facilitation
- Inspection, re-inspection
- Suspension of clinical trial, EC approval withdrawn
- Warning
- Naming
- Urgent Safety restrictions, variation of MA
- Suspension of MA,
- Revocation of MA
- GMC, prosecution



*Thank You  
for your attention !*

Questions ?



L1

 Health Canada Santé Canada

**Therapeutic Products Directorate** **Direction des produits thérapeutiques**

Health Products and Food Branch Direction générale des produits de santé et des aliments

**2.1 - Origin of Clinical Trial Regulations: Canadian Perspective**

**Presentation to APEC Preliminary Workshop on Review of Drug Development in Clinical Trials**

**Celia Lourenco, PhD,  
Manager, Clinical Group I  
Office of Clinical Trials  
Therapeutic Products Directorate**





Therapeutic Products Directorate Direction des produits thérapeutiques

*Disclaimer: the information within this presentation is based on the presenter's expertise and experience, and represents the views of the presenter for the purposes of a training workshop*



## Slide 1

---

L1

Lourenco, 28/01/2551

## Objectives

Lessons from the past and present

Basic principles

Regulatory principles

## Lessons from the Past and Present

- WWII experiments
- Thalidomide disaster (early 60's)
- Diethylstilbestrol and vaginal cancer in female offspring (1971)
- Gene therapy trials (2003)
- 20 healthy volunteers infected with tuberculosis in bioequivalence drug trial (2006)
- TGN1412: 6 healthy men in critical condition (2006)

## Basic Principles

1. Human life is valued  
therefore,  
must be safeguarded
2. All are equal

## Ethical Guidelines

- Declaration of Geneva – WMA, September, 1948
  - “...the health of my patient will be my first consideration”
- Universal Declaration of Human Rights – UN General Assembly, December 1948
  - “Everyone has the right to life, liberty and security of person”
- Nuremberg Code – 1949
  - “The voluntary consent of the human subject is absolutely essential”
  - “The experiment should be so designed and based on the results of animal experimentation and a knowledge of the natural history of the disease or other problem under study that the anticipated results will justify the performance of the experiment”
- Declaration of Helsinki – June, 1964
  - “...to protect the life, health, privacy, and dignity of the human subject”

## Impact on Canadian Framework

- IND regulations (early 60's)
- Canadian ethical guidelines for human research were first published in the late 1970's
- ICH E6: Good Clinical Practices – May, 1996  
– Has its origin in the Declaration of Helsinki
- Tri-council policy statement: Ethical Conduct for Research Involving Humans – August, 1998 (currently being updated)
- Division 5 of the Food and Drug Regulations: Drugs for Clinical Trials Involving Human Subjects – September, 2001

## Biomedical Research

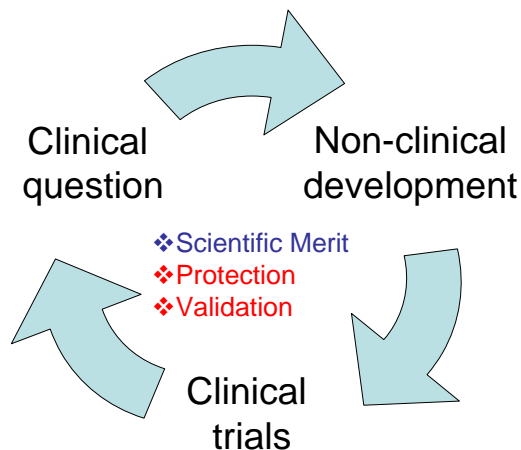

## Regulatory Principles – New Drugs

*New Drugs* must undergo clinical trials to “establish the safety” and demonstrate “substantial evidence of the clinical effectiveness of the new drug for the purpose and under the conditions of use recommended” before being authorized for marketing in Canada

## Regulatory Principles – Clinical Trials (1)

- Regulations state that a sponsor may not sell or import the drug for a clinical trial if:
  - there is insufficient information to assess the risks of the drug or the trial
  - the use of the drug for the purposes of the clinical trial endangers the health of a clinical trial subject or other person
  - the clinical trial is contrary to the best interests of a clinical trial subject
  - the objectives of the clinical trial will not be achieved

## Regulatory Principles – Clinical Trials (2)

- Incorporation of GCP into regulations:
  - Study described in a protocol
  - All information and data available on the drug are described in an Investigator's Brochure
  - Qualified Investigator is a trained and experienced licensed physician or dentist
  - Informed consent must be obtained from research subjects
  - Informed Consent Form must state the risks and anticipated benefits arising to the health of clinical trial subjects
  - REB review and ongoing oversight
  - Monitoring for adverse drug reactions, and reporting of all serious, unexpected, adverse drug reactions
  - Keep accurate records for specified time frame

## Summary

- Lessons learned from the past and present
- International movement for the protection of human rights and research volunteers
- Incorporation of human rights principles into regulations
- Research in humans must be conducted with the highest level of scientific and ethical standards
- There is public trust in the regulator, and as regulators, we have a duty to protect
- In moving forward: life-cycle of drug product, pharmacogenomics



## References

Division 5 Regulations	<a href="http://www.hc-sc.gc.ca/dhp-mps/alt_formats/hpfb-dgpsa/pdf/compli-conform/1024_e.pdf">http://www.hc-sc.gc.ca/dhp-mps/alt_formats/hpfb-dgpsa/pdf/compli-conform/1024_e.pdf</a>
Tri-Council Policy Statement – Ethical Conduct for Research Involving Humans	<a href="http://pre.ethics.gc.ca/english/pdf/TCPS%20October%202005_E.pdf">http://pre.ethics.gc.ca/english/pdf/TCPS%20October%202005_E.pdf</a>
ICH E6 – Good Clinical Practice	<a href="http://www.hc-sc.gc.ca/dhp-mps/alt_formats/hpfb-dgpsa/pdf/prodpharma/e6_e.pdf">http://www.hc-sc.gc.ca/dhp-mps/alt_formats/hpfb-dgpsa/pdf/prodpharma/e6_e.pdf</a>
WMA – Declaration of Geneva	<a href="http://www.wma.net/e/policy/c8.htm">http://www.wma.net/e/policy/c8.htm</a>
UN – Universal declaration of Human Rights	<a href="http://www.un.org/Overview/rights.html">http://www.un.org/Overview/rights.html</a>
WMA – Declaration of Helsinki	<a href="http://www.wma.net/e/policy/pdf/17c.pdf">http://www.wma.net/e/policy/pdf/17c.pdf</a>

L1

 Health Canada Santé Canada

**Therapeutic Products Directorate** **Direction des produits thérapeutiques**

Health Products and Food Branch Direction générale des produits de santé et des aliments

**2.2 – Roles and Responsibilities in the Conduct and Assessment of Clinical Trials**

Presentation to APEC Preliminary Workshop on Review of Drug Development in Clinical Trials

**Celia Lourenco, PhD,  
Manager, Clinical Group I  
Office of Clinical Trials  
Therapeutic Products Directorate**





Therapeutic Products Directorate Direction des produits thérapeutiques

*Disclaimer: the information within this presentation is based on the presenter's expertise and experience, and represents the views of the presenter for the purposes of a training workshop*



## Slide 1

---

L1

Lourenco, 28/01/2551

## Objectives

Who are the players?

What are their roles & responsibilities (R&Rs) in assessment and conduct of clinical trials?

## Players in CTs

- Regulator
- Sponsor
- Institutions/Clinical Trial Sites
- Qualified Investigators (QI) & Staff
- Research Ethics Boards
- Clinical trial subjects or legal guardians
- Data safety Monitoring Board (DSMB)
- Contract Research Organization (CRO)
- Site Management Organization (SMO)

## R&Rs of the Regulator (1)

- Implement regulations, guidelines, systems and procedures to:
  - Protect clinical trial subjects
  - Ensure scientific research has merit
  - Ensure consistency in the assessment of CTs
  - Maintain sponsor, stakeholder, and public trust
- Process and review CT applications in accordance with the regulations

## R&Rs of the Regulator (2)

- Review CT applications to determine whether:
  - There is sufficient data to support the safety of the drug in the trial
  - The trial has scientific merit
  - The safety assessments and risk management measures adequately mitigate the potential risks to trial subjects
  - All the information provided, including the safety and efficacy variables, suggest the objectives of the trial will be achieved
  - The potential risks and anticipated benefits are adequately communicated in the informed consent form
  - The quality, chemistry & manufacturing information is acceptable
  - Overall, the anticipated benefits outweigh the potential risks to trial subjects

## R&Rs of the Regulator (3)

- Provide opportunities for dialogue with the sponsor during review of CT applications
- Issue the decision
  - Letter of authorization
  - Letter of rejection: clearly communicate all deficiencies to the sponsor
- Assess safety information on the drug through analysis of ADRs, lot-release information, and other information as the trial is ongoing
- Communicate with the sponsor if concerns arise while the trial is ongoing

## R&Rs of the Regulator (4)

- Conduct inspections of CTs to:
  - Ensure protection of CT subjects
  - Verify and ensure data integrity
  - Ensure that the responsibilities of the sponsor, QI, REB, and other players, are maintained
  - Ensure the trial is conducted in accordance with the regulations and GCP
- Maintain accurate and confidential records for all regulatory functions in the review and inspection of CTs

## R&Rs of the Sponsor (1)

- [Submit an application](#) for authorization of a CT in accordance with the regulations and guidelines
- [Attest](#) that:
  - Information and material contained in, or referenced by, the application for a CT are complete and accurate and are not false or misleading
  - Will conduct the CT in accordance with the applicable regulations and Good Clinical Practices
  - Trial will not commence until the authorization is received or 30 calendar days have elapsed from time of receipt of complete application
  - Provide information during review of the CT in accordance with the regulations (2 day turnaround)
  - Maintain accurate records for specified period, accessible to inspection

## R&Rs of the Sponsor (2)

- [Provide](#) information to the regulator:
  - As requested during review
  - After authorization of the trial
    - Name of Qualified Investigator & trial site
    - Approval at each site by a properly constituted REB
    - REB refusals, if any
    - Lot release fax-back form for biologics
    - Report all serious, unexpected, adverse drug reactions
    - Protocol and/or chemistry & manufacturing amendments
    - Premature discontinuation of the CT
    - Other information as requested by the regulator
    - Comply with the regulator before, during, and after CT inspections

## R&Rs of the Sponsor (3)

- Ongoing assessment of the trial & drug:
  - Implement systems and procedures for the monitoring and assessment of safety in CTs
  - Monitor and evaluate all safety and efficacy information as it becomes available and to the extent possible with a view to assessing impact on the safety of CT subjects and the merit of the CT
  - Periodically review the investigator's brochure
  - Ensure that any DSMB, set-up to review the data in the trial, is independent and constituted by individuals with appropriate knowledge and experience
  - Keep all players informed of new information that impacts on the CT as required by local regulations and guidelines

## R&Rs of the Sponsor (4)

- In conduct of the CT, ensure:
  - Applicable regulations and GCPs are followed
  - Sufficient supply of the drug
  - Trial supplies are labelled in accordance with the regulations
  - QIs and sites have the required infrastructure, equipment, expertise, and trained staff to conduct the CT
  - Roles and responsibilities are clear to the QIs
  - Appropriate forms are developed and used consistently for recording all trial data
  - Updated safety information, including the IB, is provided to the QIs in a timely manner

## R&Rs of the Sponsor (5)

### Continued...

- Protocol amendments are authorized by the regulator and the REB prior to implementation
- Quality of the drug is maintained throughout the CT
- Serious, unexpected, adverse drug reactions are reported to the regulator and the REB
- Information is provided to the regulator when requested
- Sites are monitored and audited as appropriate, to ensure conduct of the trial continues to meet GCP, the protocol, and regulations
- All players are informed and all unused drug is retrieved where a trial is discontinued prematurely
- Accurate records are maintained for all aspects of the trial, in accordance with regulations or guidelines, as applicable

## R&Rs of Institution/QI (1)

- **Conduct** the clinical trial in accordance with the applicable regulations and GCPs, including:
  - Implement systems and procedures for the monitoring and assessment of safety in CTs
  - Obtain approval by an appropriately constituted REB and communicate this approval to the sponsor
  - Ensure staff conducting the trial have the required training and experience
  - Ensure that the objectives of the trial, procedures and tests involved, potential risks, and anticipated benefits are explained to clinical trial subjects
  - Inform subjects of their rights and provide sufficient time for the informed consent discussion
  - Supply a copy of the signed informed consent form to subjects
  - Provide support to research subjects, including the contact name & telephone number of the investigator and research ethics board chair

## R&Rs of Institution/QI (2)

### Continued...

- Provide for trial-related medical care of trial subjects
- Communicate concerns to the sponsor in a timely manner
- Support the function of the REB, inspectors, and sponsor
- Communicate serious, unexpected, ADRs to the REB, sponsor, and regulator
- Follow the protocol as written and respect the design of the trial including randomization and blinding
- Label, use, and store the drug in accordance with the regulations and the protocol or investigator's brochure
- Maintain accurate records, including source records, REB attestation of approval of all versions of the protocol and informed consent form, and all original signed informed consent forms for each subject for all versions of the protocol, as applicable

## R&Rs of the REB

- Implement systems and procedures for assessment of clinical trials, including safety
- Review the protocol, informed consent form, investigator's brochure, advertising material, compensation of trial subjects, and any other pertinent information with due regard to the current regulations, guidelines, and highest ethical standards
- Ensure the REB reviewing the trial is constituted in accordance with the regulations
- Communicate concerns to the QI in a timely manner
- Provide for annual review and approval of the clinical trial
- Maintain accurate records of all trial reviews



## Role of Clinical trial subjects or legal guardians

- By signing the informed consent form, the subject does not forfeit his/her legal rights
- Subject has the following roles:
  - Read the informed consent form and seek understanding of the CT
  - Ask questions and understand his/her rights
  - Follow carefully all directions pertaining to drug dosing, tests and procedures, and appear for CT visits as scheduled
  - Report any apparent/potential adverse drug reaction to the investigator

## Responsibilities of the DSMB

- Abide by rules of conduct (e.g., terms of reference describing frequency of meetings, how data will be analyzed, how records of proceedings will be generated, etc.)
- Implement systems and procedures for assessment of safety in clinical trials
- Conduct objective and independent review of the safety and efficacy of the drug in the trial
- Communicate concerns to the sponsor in a timely manner
- Maintain accurate records of all reviews

## Responsibilities of CROs & SMOs

- Implement systems and procedures for conduct of, and assessment of safety in, clinical trials
- Conduct CTs in accordance with the applicable regulations and guidelines
- Abide by contract signed with the sponsor
- Communicate concerns to the sponsor in a timely manner
- Maintain accurate records

## Summary

- Regulator has the legal authority, therefore, has responsibility and accountability
- Sponsor, REB, QI/Institution, and CROs/SMOs all have legal and ethical responsibilities and accountabilities
- By signing the consent form, subjects do not forfeit their legal rights

## References

Division 5 Regulations	<a href="http://www.hc-sc.gc.ca/dhp-mps/alt_formats/hpfb-dgpsa/pdf/compli-conform/1024_e.pdf">http://www.hc-sc.gc.ca/dhp-mps/alt_formats/hpfb-dgpsa/pdf/compli-conform/1024_e.pdf</a>
ICH E6 – Good Clinical Practice	<a href="http://www.hc-sc.gc.ca/dhp-mps/alt_formats/hpfb-dgpsa/pdf/prodpharma/e6_e.pdf">http://www.hc-sc.gc.ca/dhp-mps/alt_formats/hpfb-dgpsa/pdf/prodpharma/e6_e.pdf</a>

L1

 Health Canada Santé Canada

**Therapeutic Products Directorate** **Direction des produits thérapeutiques**

Health Products and Food Branch Direction générale des produits de santé et des aliments



**2.3 – Good Regulatory Practices**

**Presentation to APEC Preliminary Workshop on Review of Drug Development in Clinical Trials**

**Celia Lourenco, PhD,  
Manager, Clinical Group I  
Office of Clinical Trials  
Therapeutic Products Directorate**



 Therapeutic Products Directorate Direction des produits thérapeutiques

*Disclaimer: the information within this presentation is based on the presenter's expertise and experience, and represents the views of the presenter for the purposes of a training workshop*

## Slide 1

---

L1

Lourenco, 28/01/2551

## Good Regulatory Practices

- ✓ Develop regulations that are flexible
- ✓ Use risk management principles
- ✓ Be consistent in guidance and decision-making
- ✓ Be efficient in information and records management
- ✓ Measure and maintain performance and transparency
- ✓ Be reachable and reach out to stakeholders
- ✓ Be aware of changing regional and global factors in R&D and access to drugs

3

## Flexibility of Regulations

- Regulations should:
  - Cover principles broadly
  - Provide sufficient protection to the public
  - Strike a balance between protection of the public and enabling R&D
  - Be forward-looking, allowing flexibility for regulating in the current and future environment

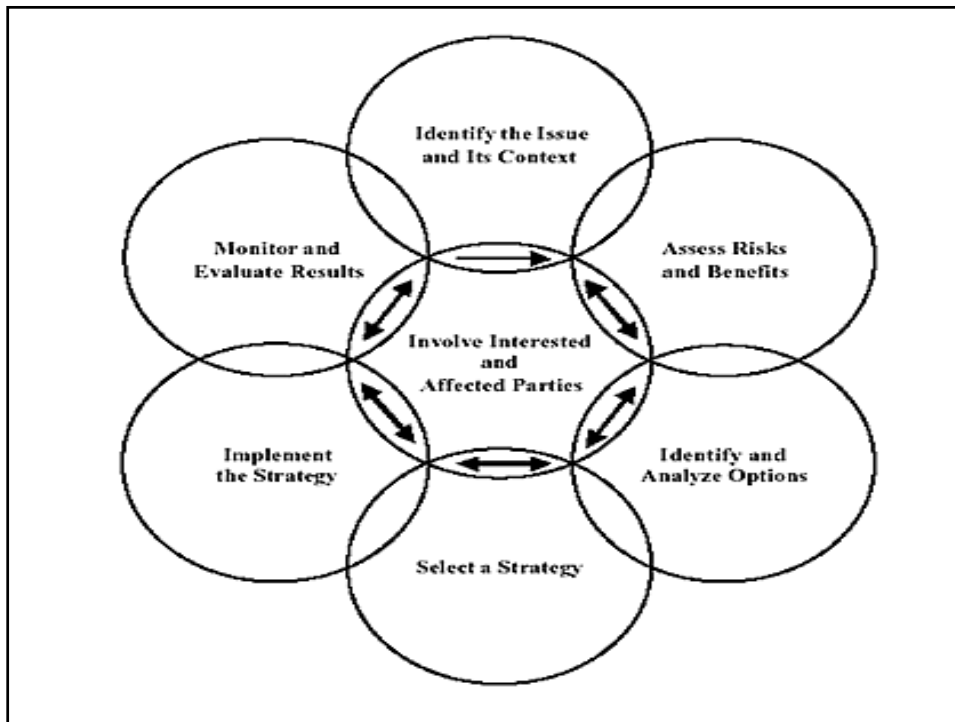

Therapeutic Products Directorate      Direction des produits thérapeutiques

## Use Risk Management Principles

- Science-based risk management, with risk-based decision-making
- Precautionary principle: “absence of full scientific certainty shall not be used as a reason to postpone decisions when faced with the threat of serious or irreversible harm”
- Proactive – take initiative to address and prevent public health & safety concerns:
  - Safety of Canadian blood system
  - Bovine spongiform encephalopathy / Creutzfeldt-Jakob disease
  - Pandemic influenza
- Know own strengths and weaknesses:
  - Consult with experts on complex scientific, medical, or regulatory issues
  - Implement and make use of scientific advisory committees

## Consistency in Guidance and Decision-Making

- Adopt international guidelines when appropriate
- Develop SOPs:
  - Good guidance practices
  - Good review practices
- Develop and implement guidelines to address regional issues
- Be aware of drivers, such as globalization

## Efficiency in Information and Records Management

- Develop and implement tools to manage documents and information submitted by sponsors
  - Maintain accurate records with a numbering system for sponsor/drug and submissions
  - Clinical trial applications, amendments and notifications
  - ADR database for integration and analysis
  - Submission allocation database
  - Clinical trial inspection database
- System to manage other information such as general enquiries
- Ensure security and maintain confidentiality of records



## Measure and Maintain Performance and Transparency

- Measure workload and performance at periodic intervals (e.g., quarterly)
- Use information on workload and performance to develop/revise business plans
- Publish performance measures periodically (e.g., annually)
  - Number of clinical trials, protocol amendments, notifications, ADRs, types of trials, etc.
  - Submission processing and review times

## Be Reacheable and Reach Out to Stakeholders

- Provide opportunities for dialogue with sponsors and stakeholders formally and informally (e.g., pre-clinical trial meetings, telephone conferencing, informal email enquiries)
- Provide for appeal processes and opportunities for reconsideration of final decisions
- Consult with all stakeholders before implementing or adopting new regulations, policies, and guidelines
- Consult with stakeholders as early as possible
- Communicate horizontally within organization
- Seek lessons learned through impact analyses

## Impact on R&D: Regional Factors

- Analyze regional factors:
  - Population (e.g., demographics, disease prevalence)
  - Health care system and infrastructure
  - Available expertise
  - National support in research funding
  - Regulatory frameworks for importation and sale of drugs
  - Geographic location and neighbouring countries

## Impact on R&D: Global Factors

Be aware of, and prepare for, global impact & trends:

- Multinational clinical trials
- Harmonization
- Decreased number of blockbuster drugs & exponential rise in generics
- Personalized medicine, pharmacogenomics
- Rising costs and emerging markets
- In choosing to place a clinical trial, companies will look for countries with the appropriate laws, along with the required population, disease prevalence, health care system, qualified investigators and staff, with high standards of professional integrity and ethics

## References

Annual Drug Submission Report	<a href="http://www.hc-sc.gc.ca/dhp-mps/alt_formats/hpfb-dgpsa/pdf/prodpharma/tpd_dpt_annual_annuel_06_e.pdf">http://www.hc-sc.gc.ca/dhp-mps/alt_formats/hpfb-dgpsa/pdf/prodpharma/tpd_dpt_annual_annuel_06_e.pdf</a>
TPD Annual Performance Report	<a href="http://www.hc-sc.gc.ca/dhp-mps/alt_formats/hpfb-dgpsa/pdf/prodpharma/tpd_rep_dpt_rap_2006-07_e.pdf">http://www.hc-sc.gc.ca/dhp-mps/alt_formats/hpfb-dgpsa/pdf/prodpharma/tpd_rep_dpt_rap_2006-07_e.pdf</a>
Decision-Making Framework for Identifying, Assessing, and Managing Health Risks (2001)	<a href="http://www.hc-sc.gc.ca/ahc-asc/pubs/hpfb-dgpsa/risk-risques_tc-tm_e.html">http://www.hc-sc.gc.ca/ahc-asc/pubs/hpfb-dgpsa/risk-risques_tc-tm_e.html</a>
Good Guidance Practices	<a href="http://www.hc-sc.gc.ca/dhp-mps/prodpharma/applic-demande/guide-ld/ggp-bpld/index_e.html">http://www.hc-sc.gc.ca/dhp-mps/prodpharma/applic-demande/guide-ld/ggp-bpld/index_e.html</a>
Ten Hallmarks of a Good Review	<a href="http://www.hc-sc.gc.ca/dhp-mps/alt_formats/hpfb-dgpsa/pdf/prodpharma/grp_bpe_princip_v2_e.pdf">http://www.hc-sc.gc.ca/dhp-mps/alt_formats/hpfb-dgpsa/pdf/prodpharma/grp_bpe_princip_v2_e.pdf</a>
Good Review Practices	<a href="http://www.hc-sc.gc.ca/dhp-mps/alt_formats/hpfb-dgpsa/pdf/prodpharma/grp_fs_bpe_fd_v2_e.pdf">http://www.hc-sc.gc.ca/dhp-mps/alt_formats/hpfb-dgpsa/pdf/prodpharma/grp_fs_bpe_fd_v2_e.pdf</a>

# Good Regulatory Practice

Junko Sato, PhD

Office of New Drug I, PMDA

APEC Preliminary Workshop on Review of Drug Development in Clinical Trials  
2007.3.17 – 21, Bangkok, Thailand



## Disclaimer

- ◆ *The information within this presentation is based on the presenter's expertise and experience, and represents the views of the presenter for the purposes of a training workshop*

APEC Preliminary Workshop on Review of Drug Development in Clinical Trials  
2007.3.17 – 21, Bangkok, Thailand



## What is Good Regulatory ?

- ◆ To provide “More Effective” “Safer”  
Drugs/ Devices to the public in a “more  
speedy” manner

APEC Preliminary Workshop on Review of Drug Development in Clinical Trials  
2007.3.17 – 21, Bangkok, Thailand



## Good Regulatory Practice

- ◆ Improvement of performance
- ◆ Transparency
- ◆ Predictability
- ◆ Be reachable and reach out to Stakeholders
- ◆ On a base of R&D and access to drugs

APEC Preliminary Workshop on Review of Drug Development in Clinical Trials  
2007.3.17 – 21, Bangkok, Thailand



## Improvement of performance

- ◆ Increase of reviewers
  - ❖ 335 to 571 (+236) reviewers
- ◆ Standardization of review process
  - ❖ Grasp the gap among review teams
  - ❖ Revise the SOP in review process
  - ❖ Catch requests of industries
- ◆ Utilization of IT system
  - ❖ Integrate databases to improve functions

APEC Preliminary Workshop on Review of Drug Development in Clinical Trials  
2007.3.17 – 21, Bangkok, Thailand



## Standardization of review process

- ◆ **Format** of Review Report
  - ❖ Template, Font, Style etc.
- ◆ **Earlier** writing of Review report
  - ❖ Identifying critical/major issues in an early stage
- ◆ Establish **Review Plan**
  - ❖ Recognize work loads
- ◆ Frequent **communications** with an applicant
  - ❖ make common understanding
- ◆ Introduce **Project Manager System**
  - ❖ To strengthen review time management

APEC Preliminary Workshop on Review of Drug Development in Clinical Trials  
2007.3.17 – 21, Bangkok, Thailand



## Transparency in Review Process

- ◆ Establishment of **General Review Principles** in PMDA

- ❖ To standardize general review policy
- ❖ To avoid inconsistent decision making
- ❖ To clear minimum check points in the review
- ❖ To accelerate review time

- Draft was almost completed
- Contents in this documents will be available in near future

APEC Preliminary Workshop on Review of Drug Development in Clinical Trials  
2007.3.17 – 21, Bangkok, Thailand



## Transparency in PMDA

- ◆ Open to our accomplishment year by year
- ◆ It is evaluated by external assessment committee
  - ❖ Evaluation Committee for Incorporated Administrative Agencies of the MHLW

APEC Preliminary Workshop on Review of Drug Development in Clinical Trials  
2007.3.17 – 21, Bangkok, Thailand



## Predictability in review process

- ◆ When will it be approved?
  - ❖ Open to applicant on our **Review Plan**
  - ❖ Share the work loads
  - ❖ It must be useful for safety measure and preparation of post-marketing surveillance
- ◆ Frequent **communications** with applicants
  - ❖ make common understanding

APEC Preliminary Workshop on Review of Drug Development in Clinical Trials  
2007.3.17 – 21, Bangkok, Thailand



## Predictability in risk/benefit balance

- ◆ Introduce Product Manger System
  - ❖ Manage safety issues of a product from development to post-marketing stages by same person
  - ❖ Detect safety signal in early stage of drug development
  - ❖ Promote to establish pharmacovigilance plan as soon as possible

APEC Preliminary Workshop on Review of Drug Development in Clinical Trials  
2007.3.17 – 21, Bangkok, Thailand





## R&D in Japan

- ◆ Current situation
  - ❖ Decrease drug developments
  - ❖ Increase of multinational studies
  - ❖ Doctors do not have enough time to conduct (cooperate?) to clinical trials
- ◆ How to resolve the problem?
  - ❖ Publication of 'Basic principles on Global Clinical Trials'
  - ❖ Grasp problems and discuss with counterparts how should we do each other

APEC Preliminary Workshop on Review of Drug Development in Clinical Trials  
2007.3.17 – 21, Bangkok, Thailand



## Be reachable and reach out to Stakeholders

- ◆ Dialog with a stakeholder in review process, if it is required.
- ◆ Dialog with a stakeholders to improve review process, consultation system, etc.
- ◆ PMDA's opinion for the development in consultation

APEC Preliminary Workshop on Review of Drug Development in Clinical Trials  
2007.3.17 – 21, Bangkok, Thailand





**Thank you for your attention !**

APEC Preliminary Workshop on Review of Drug Development in Clinical Trials  
2007.3.17 – 21, Bangkok, Thailand



L1

 Health Canada Santé Canada

**Therapeutic Products Directorate** **Direction des produits thérapeutiques**

Health Products and Food Branch Direction générale des produits de santé et des aliments

**2.4 – Regulations & Guidelines:  
CMC and Non-Clinical**

**Presentation to APEC Preliminary Workshop  
on Review of Drug Development  
in Clinical Trials**

**Celia Lourenco, PhD,  
Manager, Clinical Group I  
Office of Clinical Trials  
Therapeutic Products Directorate**





Therapeutic Products Directorate Direction des produits thérapeutiques

*Disclaimer: the information within this presentation is based on the presenter's expertise and experience, and represents the views of the presenter for the purposes of a training workshop*

## Slide 1

---

L1

Lourenco, 28/01/2551

## Objectives

Regulations and guidelines for:

Chemistry, manufacturing, and controls

Non-clinical data requirements

3

## Canadian CMC Regulations

- Schedule B compendial monographs (e.g., USP, Ph.Eur., BP)
- Division 5: drugs for clinical trials
  - Medicinal and non-medicinal ingredients and dosage form
  - Physical, chemical, and pharmaceutical properties of the drug
  - C&M information in respect of the drug, including its site of manufacture
  - Manufactured, handled, and stored in accordance with applicable GMPs
  - Labelling requirements

4

## Canadian CMC Guidelines

- Good manufacturing practices (GMPs): general guideline and Annex 2 for the manufacture of drugs used in clinical trials
- Quality (Chemistry and Manufacturing) Guidance: Clinical Trial Applications
- Preparation of the Quality Information for Drug Submissions in the CTD Format:
  - Conventional Biotherapeutic Products
  - Vaccines
  - Blood Products
  - Biotechnological Products

## CMC ICH Guidelines (1)

- Q1A(R2): Stability Testing of New Drug Substances and Products
- Q1B: Stability Testing: Photostability Testing of New Drug Substances and Products
- Q1C: Stability Testing: Requirements for New Dosage Forms
- Q1D: Bracketing and Matrixing Designs for Stability Testing of New Drug Substances and Products
- Q1E: Evaluation of Stability Data
- Q1F: Stability Data Package for Registration Applications in Climatic Zones III and IV
- Q2A: Text on Validation of Analytical Procedures
- Q2B: Validation of Analytical Procedures: Methodology

## CMC ICH Guidelines (2)

- Q3A(R): Impurities in New Drug Substances
- Q3B(R): Impurities in New Drug Products
- Q3C: Impurities: Guideline for Residual Solvents
- Q5A: Viral Safety Evaluation of Biotechnology Products Derived from Cell Lines of Human or Animal Origin
- Q5D: Derivation and Characterisation of Cell Substrates Used for Production of Biotechnological / Biological Products
- Q6B: Specifications: Test Procedures and Acceptance Criteria for Biotechnological / Biological Products
- Q7A: Good Manufacturing Practices Guide for Active Pharmaceutical Ingredients

7

## CMC Requirements from Guidelines

- At the clinical trial stage:
  - Do not require that sponsors follow ICH guidelines
  - Do not inspect manufacturing sites against the Annex 2 of the GMP
  - Expect that sponsors work towards meeting the guidelines by improving the manufacturing and control of the drug substance and drug product as the product progresses through clinical development
- Guidelines are applied at the marketing stage

## Canadian Non-Clinical Regulatory Requirements

- Division 5: drugs for clinical trials, the investigator's brochure must include
  - The pharmacological aspects of the drug, including its metabolites in all animal species tested
  - The pharmacokinetics of the drug and the drug metabolism, including the biological transformation of the drug in all animal species tested
  - Any toxicological effects in any animal species tested under a single dose study, a repeated dose study or a special study in respect of the drug
  - Any results of carcinogenicity studies in any animal species tested in respect of the drug

9

## Non-Clinical ICH Guidelines (1)

- S1A: Need for Carcinogenicity Studies of Pharmaceuticals
- S1B: Testing for Carcinogenicity of Pharmaceuticals
- S1C: Dose Selection for Carcinogenicity Studies of Pharmaceuticals
- S1C(R): Addendum to "Dose Selection for Carcinogenicity Studies of Pharmaceuticals" Addition of a Limit Dose and Related Notes
- S2A: Guidance on Specific Aspects Of Regulatory Genotoxicity Tests For Pharmaceuticals
- S2B: Genotoxicity: A Standard Battery for Genotoxicity Testing of Pharmaceuticals
- S3A: Note for Guidance on Toxicokinetics: The Assessment of Systemic Exposure in Toxicity Studies
- S3B: Pharmacokinetics: Guidance for Repeated Dose Tissue Distribution Studies

10



## Non-Clinical ICH Guidelines (2)

S4A: Duration of Chronic Toxicity Testing in Animals (Rodent and Non Rodent Toxicity Testing)

S5A: Detection of Toxicity to Reproduction for Medicinal Products

S6: Preclinical Safety Evaluation of Biotechnology-Derived Pharmaceuticals

S7A: Safety Pharmacology Studies for Human Pharmaceuticals

S7B: The Nonclinical Evaluation of the Potential for Delayed ventricular Repolarization (QT Interval Prolongation) by Human Pharmaceuticals

M3: Timing of Non-Clinical Safety Studies for the Conduct of Human Clinical Trials for Pharmaceuticals

## Non-clinical Requirements from Guidelines

- Generally require that sponsors follow all applicable ICH guidelines for the non-clinical program

## References

Annex 2: Manufacture of Drugs Used in Clinical Trials	<a href="http://www.hc-sc.gc.ca/dhp-mps/alt_formats/hpfb-dgpsa/pdf/compli-conform/clin_trials-essais_cln_e.pdf">www.hc-sc.gc.ca/dhp-mps/alt_formats/hpfb-dgpsa/pdf/compli-conform/clin_trials-essais_cln_e.pdf</a>
Pharmaceutical Quality Guidance	<a href="http://www.hc-sc.gc.ca/dhp-mps/prodpharma/applic-demande/guide-ld/clin/qual_cta_dec_e.html">www.hc-sc.gc.ca/dhp-mps/prodpharma/applic-demande/guide-ld/clin/qual_cta_dec_e.html</a>
Biologics Quality Guidances	<a href="http://www.hc-sc.gc.ca/dhp-mps/brgtherap/applic-demande/guides/index_e.html">www.hc-sc.gc.ca/dhp-mps/brgtherap/applic-demande/guides/index_e.html</a>
ICH CMC and Non- clinical guidelines	<a href="http://www.hc-sc.gc.ca/dhp-mps/prodpharma/applic-demande/guide-ld/ich/index_e.html">www.hc-sc.gc.ca/dhp-mps/prodpharma/applic-demande/guide-ld/ich/index_e.html</a>



# ICH Guideline on Clinical & Post-Marketing

Junko Sato, PhD  
Office of New Drug I, PMDA

APEC Preliminary Workshop on Review of Drug Development in Clinical Trials  
2007.3.17 – 21, Bangkok, Thailand



## Disclaimer

- *The information within this presentation is based on the presenter's expertise and experience, and represents the views of the presenter for the purposes of a training workshop*

## What is ICH ?

International Conference on Harmonization of Technical Requirements for Registration of Pharmaceuticals for Human Use

## ICH GL on Clinical

E1	The Extent of Population Exposure to Assess Clinical Safety for Drugs Intended for Long-Term Treatment of Non-Life-Threatening Conditions
E2A	Clinical Safety Data Management: Definitions and Standards for Expedited Reporting
E2B	Data Elements for Transmission of Individual Case Safety Reports
M2	Electronic Transmission of Individual Case Safety Reports Message Specification (ICH ICSR DTD Version 2.1)
E2B	E2BM Implementation Working Group Questions & Answers Version 1.1

## ICH GL on Clinical

E2C	Clinical Safety Data Management: Periodic Safety Update Reports for Marketed Drugs
E2D	Post-approval Safety Data Management: Definitions and Standards for Expedited Reporting
E2E	Pharmacovigilance Planning
E3	Structure and Content of Clinical Study Reports
E4	Dose-Response Information to Support Drug Registration
E5	Ethnic Factors in the Acceptability of Foreign Clinical Data

## ICH GL on Clinical

E6	Guideline for Good Clinical Practice
E7	Studies in Support of Special Populations: Geriatrics
E8	General Considerations for Clinical Trials
E9	Statistical Principles for Clinical Trials
E10	Choice of Control Group and Related Issues in Clinical Trials
E11	Clinical Investigation of Medicinal Products in the Pediatric Population

## ICH GL on Clinical

E12	Principles for Clinical Evaluation of New Antihypertensive Drugs
E14	The Clinical Evaluation of QT/QTc Interval Prolongation and Proarrhythmic Potential for Non-Antiarrhythmic Drugs (May 12, 2005)
E15	Definitions for Genomic Biomarkers, Pharmacogenomics, Pharmacogenetics, Genomic Data and Sample Coding Categories

## History of ICH

- ✓ 1990.4. Establishment of ICH
- ✓ 1991.11. First Conference
- ✓ Purpose: To Harmonise of Regulation on NDA in EU, US and Japan.
  - ☆ Mutual submission of NDA
  - ☆ To avoid duplication of studies
  - ☆ To provide excellent drugs to patients speedy
  - ☆ To contribute to the protection of public health from an international perspective (added upon revision in 2000)

## Accomplishment of ICH

✓ Over 50 guidelines are harmonised, and adopted as regulations

1. S: Safety (Non-clinical)
2. E: Efficacy (Clinical)
3. Q: Quality
4. M: Multi-disciplinary

## After ICH5

- Recent interactions between the regulators involved in ICH have identified post marketing activities as a future area where increased regulatory co-operation can help to contribute to the enhancement of the protection of the health of citizens on a more international basis.

## Harmonisation on Post-marketing

✓ Harmonised guideline in post-marketing area

- Electronic Transmission of
- PSUR
- Post-approval Safety Data Management
- Pharmacovigilance planning

➡ Expectation to accelerate globalization of safety monitoring

## ICH-E5

### Ethnic Factors in the Acceptability of Foreign Clinical Data



## Background

- Utilization of foreign clinical data
- However,
  - ethnic differences may affect the medication's safety, efficacy, dosage and dose regimen in the new region
  - The regulatory authority in the new region has often requested that all, or much of, the foreign clinical data in support of registration be duplicated in the new region.
  - Requirements for extensive duplication of clinical evaluation for every compound can delay the availability of new therapies and unnecessarily waste drug development resources.

## Objective is ICH-E5

- To describe the characteristics of foreign clinical data that will facilitate their extrapolation to different populations and support their acceptance as a basis for registration of a medicine in a new region\*.
- To describe regulatory strategies that minimize duplication of clinical data and facilitate acceptance of foreign clinical data in the new region.
- To describe the use of bridging studies\*, when necessary, to allow extrapolation of foreign clinical data to a new region.
- To describe development strategies capable of characterizing ethnic factor influences on safety, efficacy, dosage and dose regimen.

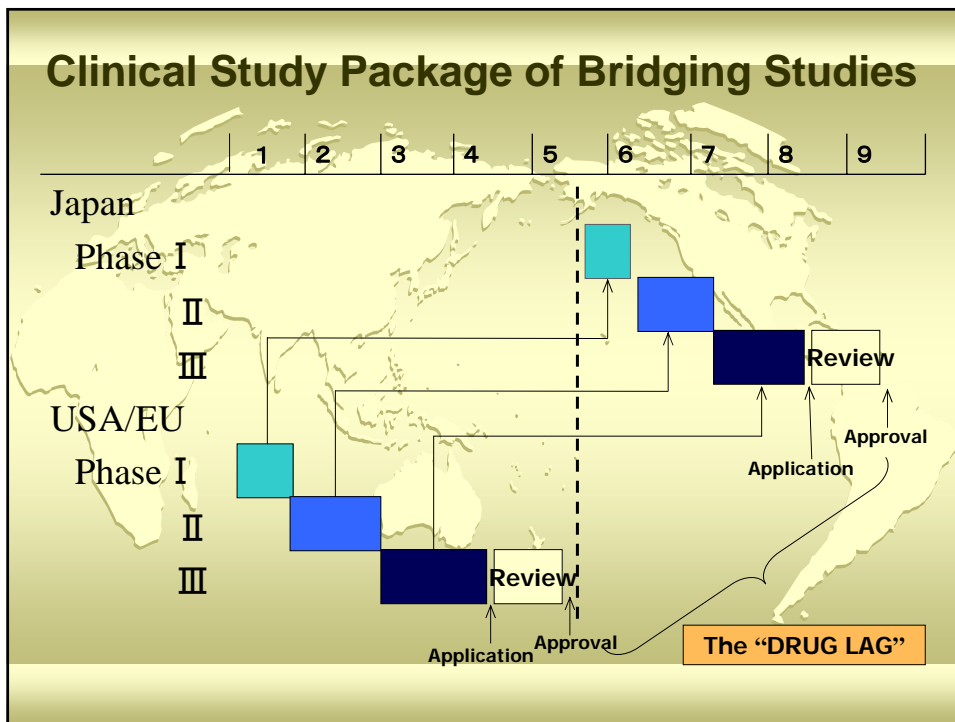
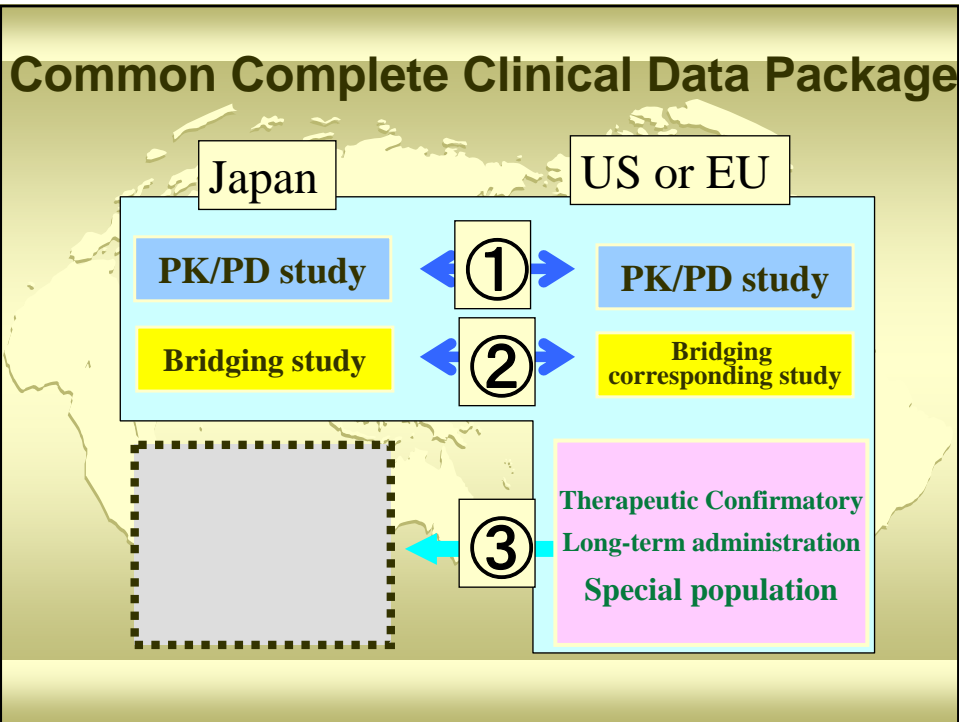

## Involvement in Global Clinical Study

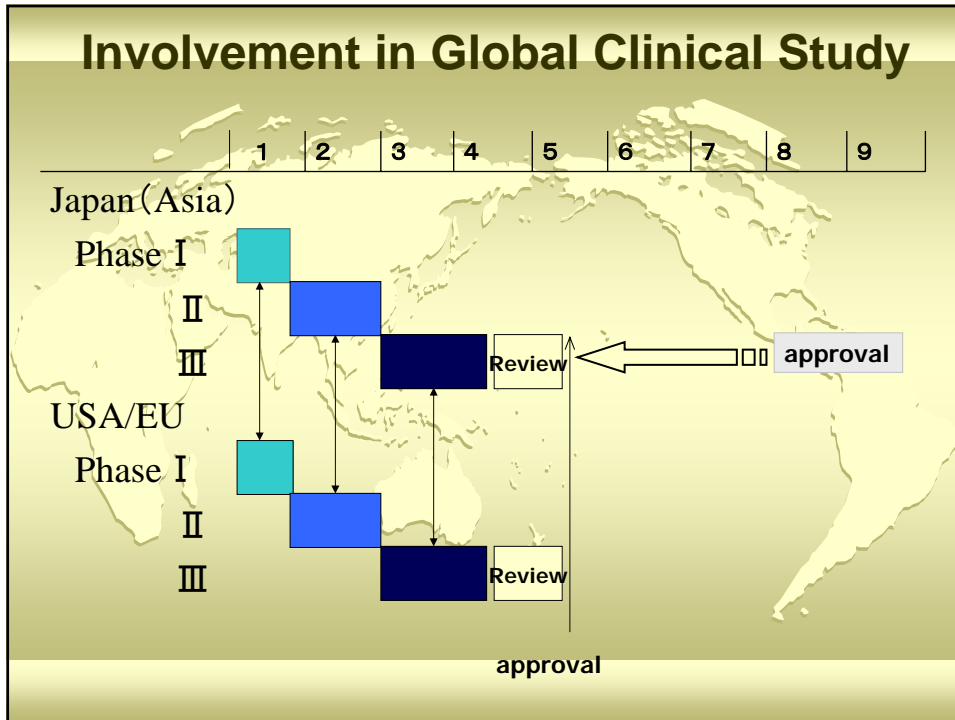

## Developing GL in ICH (Clin.)

- Development Safety Update Report (E2F)
- Preclinical Guideline on Oncology Therapeutic Development (S9)

<http://www.ich.org/cache/compo/276-254-1.html>



# Inspection (GCP & GMP)

Junko Sato, PhD  
Office of New Drug I, PMDA

APEC Preliminary Workshop on Review of Drug Development in Clinical Trials  
2007.3.17 – 21, Bangkok, Thailand



## Disclaimer

- ❖ *The information within this presentation is based on the presenter's expertise and experience, and represents the views of the presenter for the purposes of a training workshop*

APEC Preliminary Workshop on Review of Drug Development in Clinical Trials  
2007.3.17 – 21, Bangkok, Thailand



# GMP

- ❖ Good Manufacturing Practice
- ❖ Require for a manufacturing business license
- ❖ Compliance with the Regulations for Buildings and Equipment of Pharmacies, etc.
- ❖ Specify standards for structures and equipment in manufacturing plants for each manufacturing category

APEC Preliminary Workshop on Review of Drug Development in Clinical Trials  
2007.3.17 – 21, Bangkok, Thailand



# Compliance with the GMP ordinance

- ❖ Specify
  - ❖ Standards for structures and equipment required for product concerned
  - ❖ Standards for manufacturing control and quality control for each manufactured product
- ❖ Need for approval of drug concerned

APEC Preliminary Workshop on Review of Drug Development in Clinical Trials  
2007.3.17 – 21, Bangkok, Thailand



## GMP compliance review

- ❖ Four grade
  - ❖ A : (compliance) Manufacturing is performed properly
  - ❖ B : (Slightly defective) There is little effect on drug quality but improvement necessary for complete compliance with control regulation
  - ❖ C : (Moderately defective) Effect on drug quality cannot be ruled out and improvement necessary for compliance with control regulations
  - ❖ D : (Seriously defective) Clear violation of control regulations

APEC Preliminary Workshop on Review of Drug Development in Clinical Trials  
2007.3.17 – 21, Bangkok, Thailand



## GCP

- ❖ Good Clinical Practice
- ❖ Establish for an ethnically correct and scientifically accurate implementation of clinical studies
- ❖ The concept is based on 'Declaration of Helsinki'
  - ❖ WORLD MEDICAL ASSOCIATION DECLARATION OF HELSINKI  
Ethical Principles for Medical Research Involving Human Subjects

<http://www.wma.net/e/policy/b3.htm>

APEC Preliminary Workshop on Review of Drug Development in Clinical Trials  
2007.3.17 – 21, Bangkok, Thailand



## GCP(E6) in ICH

- ❖ harmonised (*Step 4*) in May 1996
  - <http://www.ich.org/LOB/media/MEDIA482.pdf>
- ❖ Describe the responsibilities and expectations of all participants in the conduct of clinical trials, including investigators, monitors, sponsors and IRBs
- ❖ Cover
  - ❖ aspects of monitoring
  - ❖ reporting and archiving of clinical trials
  - ❖ incorporating addenda on the Essential Documents and on the Investigator's Brochure

APEC Preliminary Workshop on Review of Drug Development in Clinical Trials  
2007.3.17 – 21, Bangkok, Thailand



## Regulation related with ICH-GCP

- ❖ **EU** : Adopted by CPMP, July 96, issued as CPMP/ICH/135/95/Step5, Explanatory Note and Comments to the above, issued as CPMP/768/97
- ❖ **MHLW** : Adopted March 97, PAB Notification No.430, MHLW Ordinance No.28
- ❖ **FDA** : Published in the Federal Register, Vol. 62, No. 90, May 9, 1997, pages 25691-25709E7

APEC Preliminary Workshop on Review of Drug Development in Clinical Trials  
2007.3.17 – 21, Bangkok, Thailand







**Thank you for your attention !**

APEC Preliminary Workshop on Review of Drug Development in Clinical Trials  
2007.3.17 – 21, Bangkok, Thailand





## Overview of Drug Development

Namrata Bahadur  
Head of Clinical Development & Medical Affairs  
Emerging Growth Markets  
17<sup>th</sup> – 21<sup>st</sup> March, Bangkok

 NOVARTIS

© 2008 Novartis

## Disclaimer

---

- *The information within this presentation is based on the presenter's expertise and experience, and represents the views of the presenter for the purposes of a training workshop*

2 | Presentation Title | Presenter Name | Date | Subject | Business Use Only

 NOVARTIS

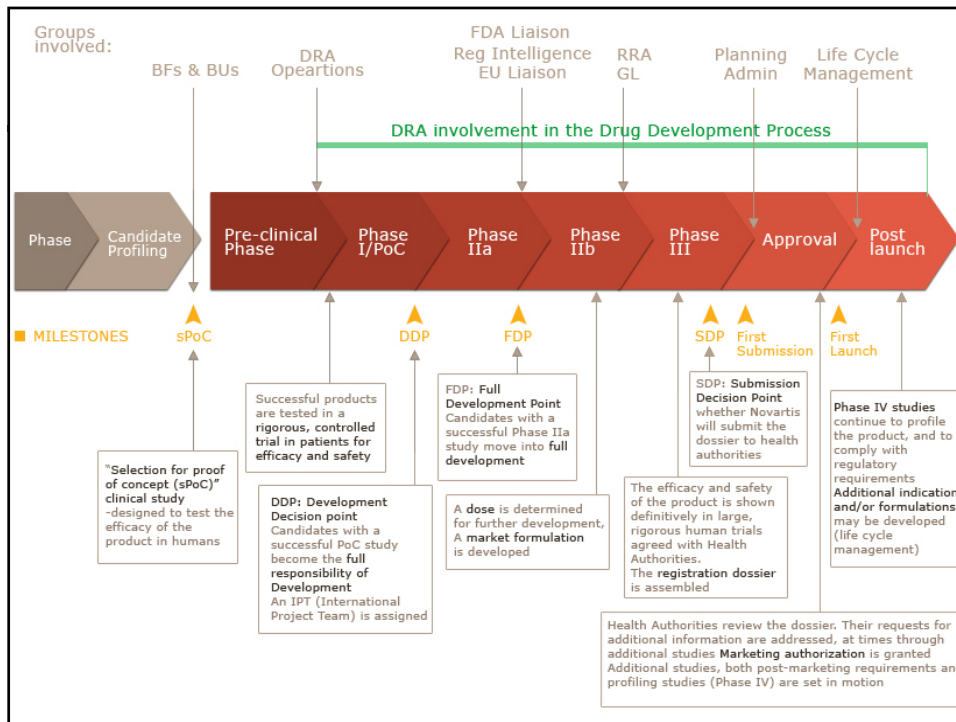

## Phases of Clinical Trials

Definition	Study types included
<p><b>Phase I</b> Tolerability or PK as primary endpoint in the protocol, independent of the study population and secondary parameters</p>	<ul style="list-style-type: none"> <li>▪ Safety &amp; Tolerability studies (Single/ multiple dose in patients or healthy volunteers)</li> <li>▪ Oncology studies in patients with tolerability / MTD as primary endpoint (efficacy might be a secondary endpoint)</li> <li>▪ Drug-Drug interaction &amp; Food Effect</li> <li>▪ PK in renal or hepatic impaired patients</li> </ul>
<p><b>Phase IIA</b> Exploratory (non-pivotal) study that has clinical efficacy, Pharmacodynamics or biological activity as primary endpoint, conducted in patients or healthy volunteers.</p>	<ul style="list-style-type: none"> <li>▪ Proof of concept, efficacy, or mechanism</li> <li>▪ Mechanistic studies</li> <li>▪ Dose range exploration</li> <li>▪ Pilot studies</li> </ul>
<p><b>Phase IIB</b> Definite dose range finding study in patients with efficacy as primary endpoint. Exceptionally, Phase II studies can be used as pivotal trials, if the drug is intended to treat life-threatening or severely-debilitating illnesses as in oncology indications</p>	<ul style="list-style-type: none"> <li>▪ Definite dose finding studies</li> <li>▪ Extension studies of Phase IIB studies</li> </ul>

## Phases of Clinical Trials

Definition	Study types included
<p><b>Phase IIIA</b> A Pivotal* study that is a trial designed &amp; executed to get statistically significant evidence of efficacy and safety as required by HAs for NDA / sNDA approval. It also includes studies with the aim to include claims into the label as well as Postmarketing commitments.</p>	<ul style="list-style-type: none"> <li>▪ Pivotal studies (vs placebo / comparator)</li> <li>▪ Long term safety studies for registration</li> <li>▪ Local registration studies</li> <li>▪ Post marketing study commitments</li> <li>▪ Phase IIIA extension studies</li> </ul>
<p><b>Phase IIIB</b> A study started prior to approval and whose primary intention is support of publications rather than registration or label changes. The results are not intended to be included in the submission dossier.</p>	<ul style="list-style-type: none"> <li>▪ Studies intended to support publication, claims or to prepare launch, which start before approval but are not intended for Regulatory submissions</li> </ul>
<p><b>Phase IV</b> A study started after approval with primary intention to support publications rather than registration or label changes. The results are not intended to be included in a submission dossier.</p>	<ul style="list-style-type: none"> <li>▪ Post Marketing Surveillance studies</li> <li>▪ Studies intended to support publication claims</li> </ul>

5 | Presentation Title | Presenter Name | Date | Subject | Business Use Only



## Clinical Development Plan (CDP)

- It bridges the gap between vision and the day - to - day activities of large multidisciplinary organizations.
- The vision is transformed into distinct implementation phases and discrete steps, called clinical studies, each with well defined milestones and deliverables.

6 | Presentation Title | Presenter Name | Date | Subject | Business Use Only



## Stages of Clinical Development Plan

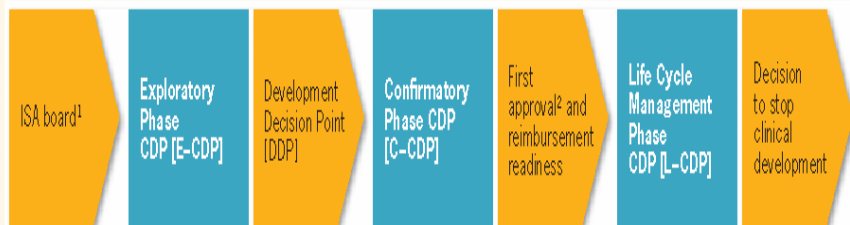

- 1) ISA = Integrated Safety Assessment  
 2) First approval typically = US or EU or J

## Clinical Experts contribute to all Phases of Drug Development

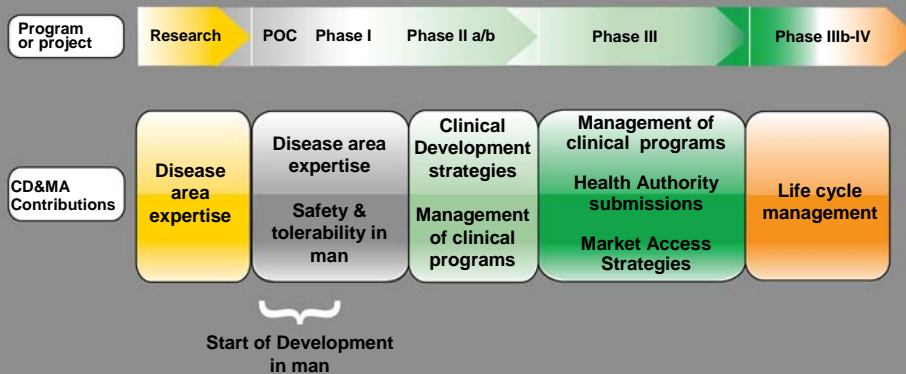

## Adaptive Designs in Clinical Development

- **Adaptive and Seamless designs** : using accumulating data to decide on how to modify aspects of the trial without undermining the validity and integrity of the trial
  
- **Adaptations can include**
  - Early stopping (futility, early rejection)
  - Sample size re-assessment
  - Treatment allocation ratios
  - Treatment arms (dropping, adding arms)
  - Hypotheses (Non-inferiority vs. superiority)
  - Population (inclusion / exclusion criteria; subgroups)
  - Test the statistics
  - Combine trials / treatment phases

9 | Presentation Title | Presenter Name | Date | Subject | Business Use Only



## Classical Full Development

- **Fixed Trial Designs Paradigm**, in particular for Phase III
  - Standard trial designs allow **little learning** during the conduct of the trial
  - “Established” adaptations are used in **group-sequential trials** where stopping for superiority or futility can be done according to pre-defined rules at interim analyses
  - Clearly **separated development phases** (II and III)
  - If applied to all clinical projects one **misses opportunities** for better use of information and more ethical drug development

10 | Presentation Title | Presenter Name | Date | Subject | Business Use Only



## Classical Phase III : Confirmation, Hypothesis Testing and Error Control

### ▪ Proof of efficacy in phase III trials:

- Show that observed treatment effect is 'real' and not just random via testing of statistical hypotheses
- **Regulatory practice and guidelines (eg. ICH E9) ask that the false positive error rate is controlled for pivotal trials (usually 2.5%)**
- Trial designs, analysis and decisions rules at interim analysis **are pre-defined**
- Emphasis on trial '**integrity**' (eg regarding confidentiality of interim results)

### ▪ Error control:

- Multiple hypothesis testing or changes of design characteristics at interim **alters the false positive error rate** of a standard statistical test

11 | Presentation Title | Presenter Name | Date | Subject | Business Use Only



## Adaptive / Seamless phase II/Phase III trial

### Primary objective - to combine "treatment selection" and "confirmation" in one trial

- Enroll patients into the trial
- During the trial, select the optimal dose (or population) based on interim data
  - Based on surrogate marker, early read-out of endpoint, or primary endpoint
- Enrollment continues only on the selected dose and the comparator arm

**All data** from chosen arm and comparator is used in final analysis, using novel statistical methods for combining evidence from **1<sup>st</sup> and 2<sup>nd</sup>** stage to control false positive error rate and maintaining trial integrity

12 | Presentation Title | Presenter Name | Date | Subject | Business Use Only



## Comparison of ASD for treatment selection with separate phase II and III trials

- **Advantages of Adaptive seamless designs :**
  - Shorter overall development time → effective drugs are made available earlier for the patients
  - Increase in information value given the same number of patients
  - Long term safety available earlier (extension of Stage I patients)
- **Logistical difficulties :**
  - Number of treatment groups can change during trial → resulting implications in drug supply
  - Centers would have to be made aware of flexible sample sizes
  - Informed consent may need to be modified at interim
  - **Sufficient Health Authority interaction**
  - Careful consideration of trial integrity issues, including the interim analysis , decision process and personnel

13 | Presentation Title | Presenter Name | Date | Subject | Business Use Only



## RAD001+Femara in Advanced Breast Cancer

### Motivation for adaptation

**Selection** of appropriate **patient sub-group** and confirmation of benefit in one seamless **phase II / III** trial

### Design specifications: 2-stage seamless adaptive design

#### Stage 1

- sub-group selection (options: sub-group or all-patients)
- futility decision at two time points
- sub-group considered is defined upfront, based on evidence external to the trial
- Sample size could be adjusted at interim points

#### Stage 2

- achieve confirmation of treatment benefit while maintaining integrity of trial (false positive rate and bias are controlled)

14 | Presentation Title | Presenter Name | Date | Subject | Business Use Only





## RAD001+Femara in Advanced Breast Cancer

### Adaptive trial design were reviewed by FDA and EMEA, and considered acceptable for the trial

Careful consideration and detail was required for the interim analysis and decision process

- What data will be needed to decide to adapt?
- Who will see this data, and make this decision?
- Will the results of this decision bias the trial?

**Overall, a positive response**

## Final Remarks

- Need for **more efficient drug development process** is recognised by all stakeholders.
- Key value of adapting is not in reducing sample size, but given a constant sample size, **increase the information value**, thus making adaptive designs more ethical/efficient
- **Ethical reasons justify novel adaptive designs**, which combine learning and confirmation in one single trial while controlling the overall type I error rate
- Novartis is committed and dedicated to invest in Research & Development of ASD on a global level while being in **continuous discussions with Health Authorities**

L1

 Health Canada Santé Canada

**Therapeutic Products Directorate** **Direction des produits thérapeutiques**

Health Products and Food Branch Direction générale des produits de santé et des aliments

**3 – Overview of Drug Development: regulator’s perspective**

**Presentation to APEC Preliminary Workshop on Review of Drug Development in Clinical Trials**

**Celia Lourenco, PhD,  
Manager, Clinical Group I  
Office of Clinical Trials  
Therapeutic Products Directorate**





Therapeutic Products Directorate Direction des produits thérapeutiques

*Disclaimer: the information within this presentation is based on the presenter's expertise and experience, and represents the views of the presenter for the purposes of a training workshop*

## Slide 1

---

L1

Lourenco, 28/01/2551

## Objectives

- Phases of clinical trials
- Life of drug as seen by the regulator
- Common drug targets and future directions
- Current and future challenges and drivers for the regulator

3

## Phases of Clinical Trials

- Initial safety & tolerability
- Determine safe dosage range
- PK / PD
- 20 – 80 subjects

Phase I

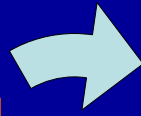

Phase II

- Explore efficacy
- Dose response
- Continue evaluation of safety
- 100 – 300 subjects

Drug product  
life-cycle

Phase III

- Confirm efficacy
- Continue evaluation of safety
- Compare to commonly used treatments
- Collect information for safe use
- 1,000 – 5,000 subjects

Phase IV



- Post-market optimization
- Safety in the general population
- Patient population sample

## Drug Molecule Life as Seen by Regulator

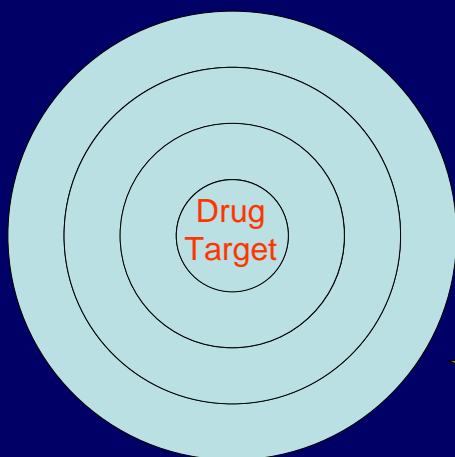
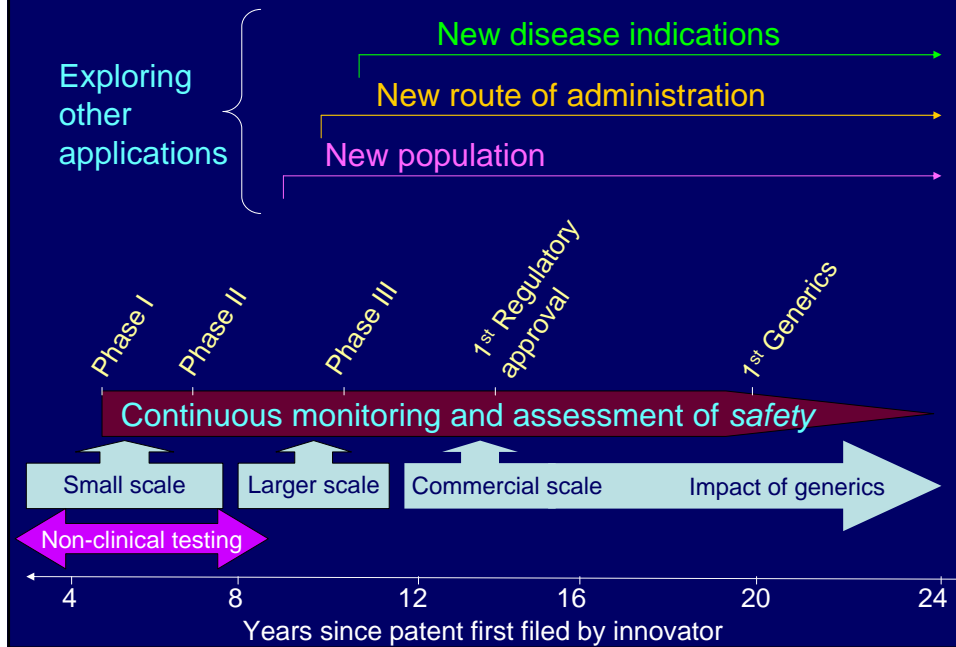

Dr. Paul Ehrlich coined the term “magic bullet” ~1900 and discovered Salvarsan® (arsphenamine), a treatment for syphilis

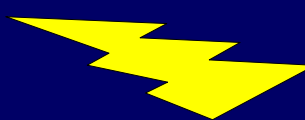

“Magic bullet!”



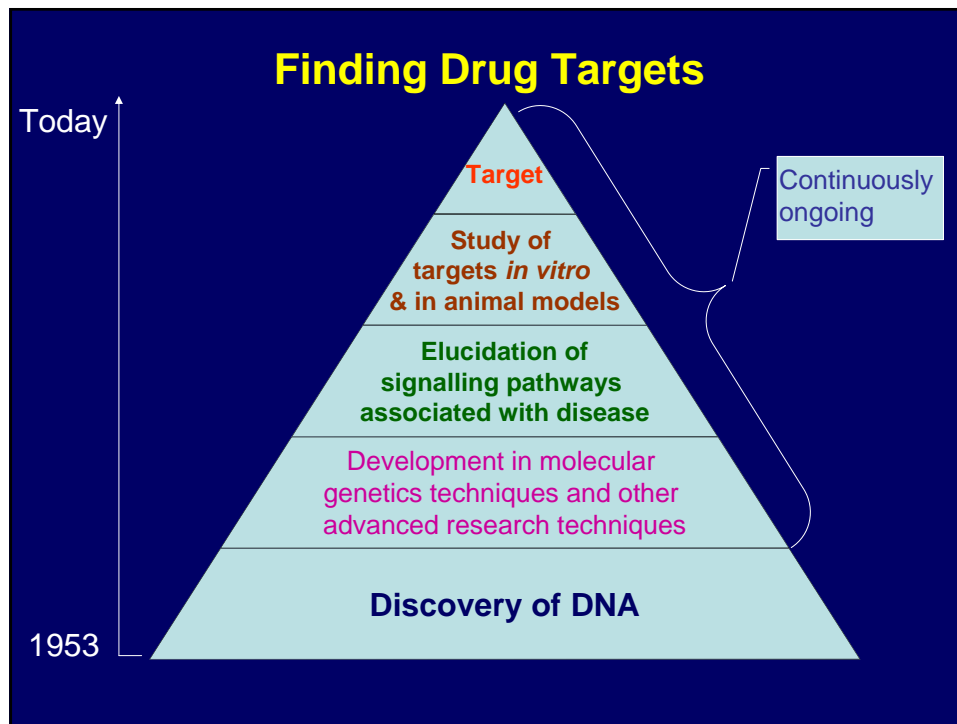

Therapeutic Products Directorate      Direction des produits thérapeutiques

## Targets for Drug Development

Unmet medical needs...

- Oncology - angiogenesis, cell signalling receptors and molecules in tumour growth
- Cardiovascular and metabolic diseases – type 2 diabetes, obesity, atherosclerosis/thrombosis
- CNS - Alzheimer's Disease, Parkinson's disease, affective disorders
- HIV / AIDS - novel targets in viral life cycle
- Infectious diseases - hepatitis B and C, influenza
- Asthma, COPD
- Autoimmune and inflammatory diseases - arthritis, psoriasis, inflammatory bowel disease, multiple sclerosis

## Future Directions (1)

- Current approach in drug development is focused on targeting specific cell signalling pathways
- Despite new targets such as receptor tyrosine kinases, tumour necrosis factor, cyclooxygenase-2, vascular endothelial growth factor, bcr-abl, proteasomes, immunomodulators, etc., still have ineffective therapies with serious side effects
- 100's of genes could be disrupted in different cancers and in other diseases
- Multiple molecular players & signalling networks in disease
- Need better understanding of drug targets and long-term safety outcomes

## Future Directions (2)

- Need to focus drug development on safety and efficacy
- Early detection of potential pitfalls using biomarkers, surrogate markers, imaging techniques, phase 0 trials
- Complexity of the mechanisms of disease such as oncogenesis may require targeting multiple targets in sequence or in parallel, for induction and maintenance of disease remission
- Complexity of the mechanisms of disease should drive future research to better understand the mechanisms and translate knowledge into clinical drug research
- Need to continue focus on developing products to address potential urgent public health needs (e.g., pandemic influenza)

## Current and Future Challenges and Drivers

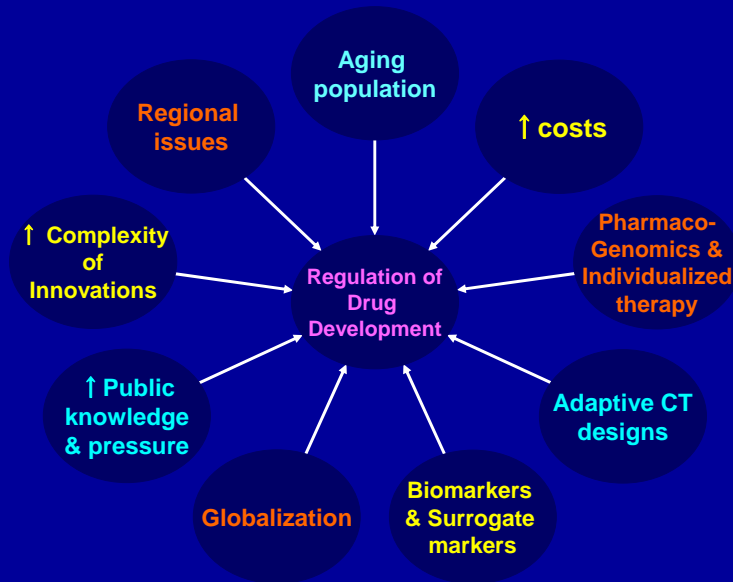

**Multidisciplinary = ↑ collaboration**

**Regulatory modernization to keep  
pace with advances**



## References

Aggarwall, B.B. et al., J. Cell Biochem., V.102(3):580-592, 2007	Title: targetting cell signaling pathways for drug discovery: An old lock needs a new key
FDA's Critical Path Initiative - Report	<a href="http://www.fda.gov/oc/initiatives/criticalpath/reports/opp_report.pdf">www.fda.gov/oc/initiatives/criticalpath/reports/opp_report.pdf</a>
FDA's Critical Path Initiative – Opportunities List	<a href="http://www.fda.gov/oc/initiatives/criticalpath/reports/opp_list.pdf">www.fda.gov/oc/initiatives/criticalpath/reports/opp_list.pdf</a>

# Overview of Drug Development Reviewers Perspective

Junko Sato, PhD  
Office of New Drug I, PMDA

APEC Preliminary Workshop on Review of Drug Development in Clinical Trials  
2007.3.17 – 21, Bangkok, Thailand



## Disclaimer

- *The information within this presentation is based on the presenter's expertise and experience, and represents the views of the presenter for the purposes of a training workshop*

APEC Preliminary Workshop on Review of Drug Development in Clinical Trials  
2007.3.17 – 21, Bangkok, Thailand



## Objectives

- What kind of drug should be developed?
- What do we require in trial of each phase?
- Approval is goal ?!
- Post-marketing committment
- Challenge in drug development

APEC Preliminary Workshop on Review of Drug Development in Clinical Trials  
2007.3.17 – 21, Bangkok, Thailand



## What kind of drug should be developed?

- Disease Area
  - Area of no effective drugs
    - Ex. Avian Flu etc.
- New mechanism of action
  - Expectation to provide more efficacy and safer

What are problems in treatment for the disease ?  
Be sensitive to medical needs !

APEC Preliminary Workshop on Review of Drug Development in Clinical Trials  
2007.3.17 – 21, Bangkok, Thailand



## What do we require in trial of each phase?

### • Non-clinical

- Adequate studies are conducted ?
- Make the character of drug clear

### • Phase I

- MTD (Maximally Tolerance Dose) ?
- ADME in healthy volunteers (single, multi)

APEC Preliminary Workshop on Review of Drug Development in Clinical Trials  
2007.3.17 – 21, Bangkok, Thailand



## What do we require in trial of each phase?

### • Phase II

- ADME in patients
- Optimal dosage to use in phase III is selected ?

### • Phase III

- Confirm efficacy and safety ?
- Positioning in therapeutic area ?

APEC Preliminary Workshop on Review of Drug Development in Clinical Trials  
2007.3.17 – 21, Bangkok, Thailand



## Approve **No !!** goal ???

- Approval is just 'through point' in lifecycle of the drug.
- Applicant and Regulator must identify
  - What information were collected ?
  - What things are brought out ?
  - What are unclear issues ?
  - Rack of data ?

APEC Preliminary Workshop on Review of Drug Development in Clinical Trials  
2007.3.17 – 21, Bangkok, Thailand



## PMDA recommend

- Identify the information need for proper use
- What data is required until approval?
- What data is collected in early phase of post-marketing ?
- Discuss where should we put 'Submission and Approval' on drug life-cycle

APEC Preliminary Workshop on Review of Drug Development in Clinical Trials  
2007.3.17 – 21, Bangkok, Thailand





## Challenge in drug development

Simultaneous NDA submission  
Simultaneous approval  
in each area

Simultaneous development

APEC Preliminary Workshop on Review of Drug Development in Clinical Trials  
2007.3.17 – 21, Bangkok, Thailand



## PMDA encourages to include Japan in Global Drug Development

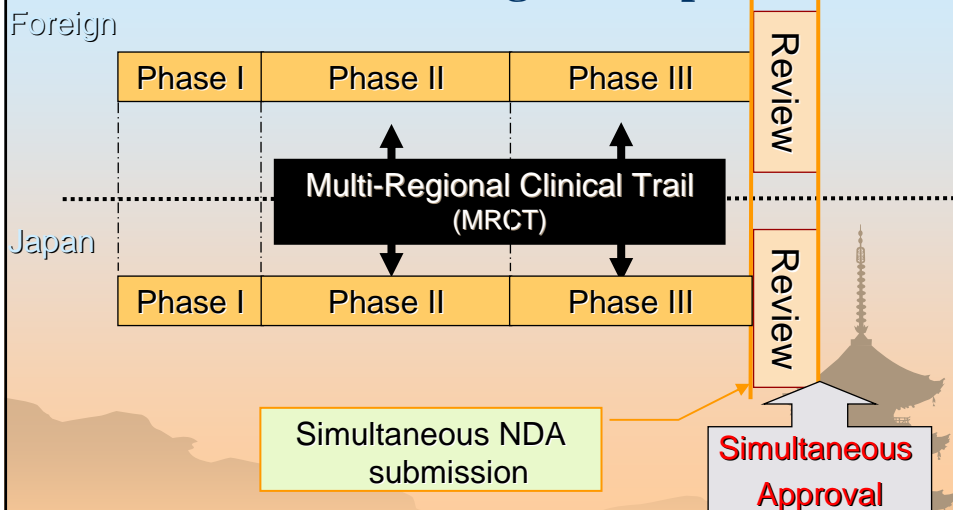

APEC Preliminary Workshop on Review of Drug Development in Clinical Trials  
2007.3.17 – 21, Bangkok, Thailand



## Face to face consultation related to Global Clinical Trial

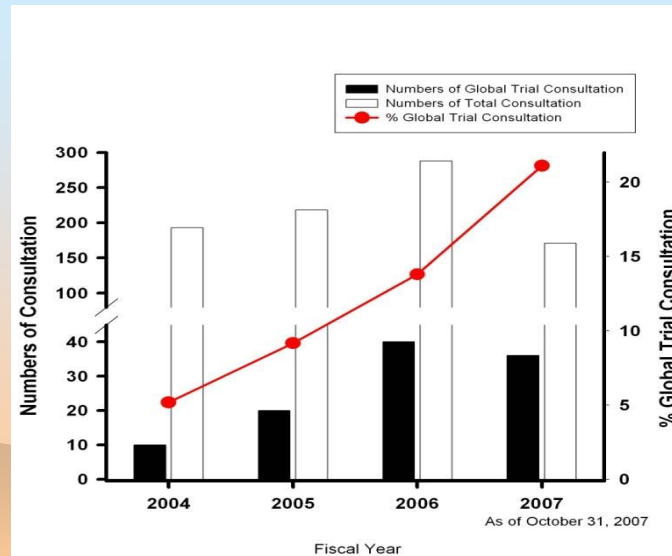

APEC Preliminary Workshop on Review of Drug Development in Clinical Trials  
2007.3.17 – 21, Bangkok, Thailand



## Basic Principles on Global Clinical Trials

- **Final Notification** was published on Sep. 28th, 2007
  - Original draft was published on March 2007 and was revised based on public comments (April 2nd to May 2nd, 2007)
- **Key Messages**
  - recommend to include **Japan** in Global Drug Development
  - include enough numbers of **Japanese patients** to show consistent results
  - encourage sponsor to **discuss with PMDA** about details of global drug developments

<http://www.pmda.go.jp/operations/notice/2007/file/0928010-e.pdf>

APEC Preliminary Workshop on Review of Drug Development in Clinical Trials  
2007.3.17 – 21, Bangkok, Thailand





## Contents in the document (Q & A)

- Q1. **Basic requirements ?**
- Q2. **Timing ?**
- Q3. A necessity of **Phase I or PK information** in Japanese ?
- Q4. A necessity of a **dose-finding study** in Japanese ?
- Q5. **Recommend to discuss about details and issues in a case at PMDA consultation**
- Q6.
- Q7.
- Q8. Appropriateness to conduct a **technical site change of trial to the global trial in Japan** separately
- Q9. Requirement for a **control group ?**
- Q10. How to define **concomitant medications or therapies**
- Q11. **Desirable disease area**
- Q12. A **flow-chart** for conducting a global trial

APEC Preliminary Workshop on Review of Drug Development in Clinical Trials  
2007.3.17 – 21, Bangkok, Thailand



## Increasing of Asian Studies

- Economic reason (low-budget)
- High motivation of investigators & patients
- Good progress on patient recruitment
- Less ethnic difference within Asian

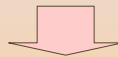

Positive impact on **Global Development**

APEC Preliminary Workshop on Review of Drug Development in Clinical Trials  
2007.3.17 – 21, Bangkok, Thailand





## East Asian Pharmaceutical Regulatory Symposium 2008

Mon. April 14–Tue. April 15, 2008 Tokyo International Forum

<http://www2.convention.co.jp/eaprs2008ph/>

- East Asian Pharmaceutical Regulatory Symposium will be held in Tokyo on April 14 and 15, 2008
  - Strengthen cooperation among Asian Regulatory Agency
  - Promote drug developments in Asia
    - Director General Level and other officials in a regulatory agency are invited from SFDA (China), KFDA (Korea) and other Asian countries

APEC Preliminary Workshop on Review of Drug Development in Clinical Trials  
2007.3.17 – 21, Bangkok, Thailand



## Information

- **PMDA HOMEPAGE**  
<http://www.pmda.go.jp/index-e.html/>
- **PMDA DRUG Information**  
<http://www.info.pmda.go.jp/>
- **E-mail:**  
[sato-junko@pmda.go.jp](mailto:sato-junko@pmda.go.jp)

# Thank you for your attention

APEC Preliminary Workshop on Review of Drug Development in Clinical Trials  
2007.3.17 – 21, Bangkok, Thailand



L1

 Health Canada Santé Canada

**Therapeutic Products Directorate** **Direction des produits thérapeutiques**

Health Products and Food Branch Direction générale des produits de santé et des aliments



**4.1 – Objectives of Clinical Trial Assessment**

**Presentation to APEC Preliminary Workshop on Review of Drug Development in Clinical Trials**

**Celia Lourenco, PhD,  
Manager, Clinical Group I  
Office of Clinical Trials  
Therapeutic Products Directorate**



Therapeutic Products Directorate Direction des produits thérapeutiques

*Disclaimer: the information within this presentation is based on the presenter's expertise and experience, and represents the views of the presenter for the purposes of a training workshop*

## Slide 1

---

L1

Lourenco, 28/01/2551

## Overview

- Overarching objectives of clinical trial assessment
- Preliminary considerations
- Process in clinical trial assessment
- Chemistry, manufacturing, and controls
- Clinical component
- Regulatory decision

## Objectives of Clinical Trial Assessment

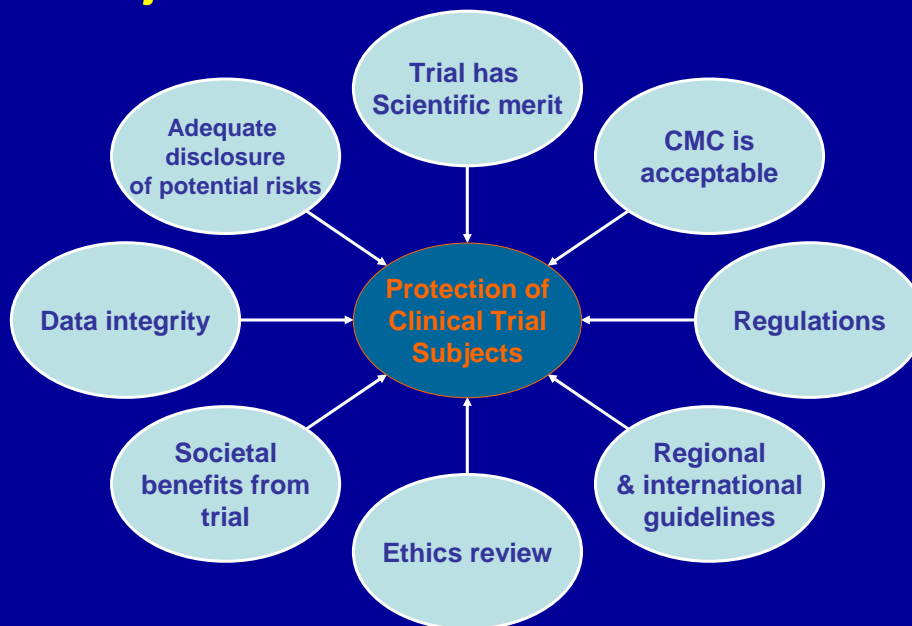

## Preliminary Considerations

- *Carry out a quick scan of the application to determine if there could be major gaps*
- This helps in prioritization, obtaining information and mobilizing expertise for decision-making:
  - Stage of development / phase of trial?
  - Disease target?
  - Subject population?
  - Potential safety concern(s) in drug class?
  - Sponsor?

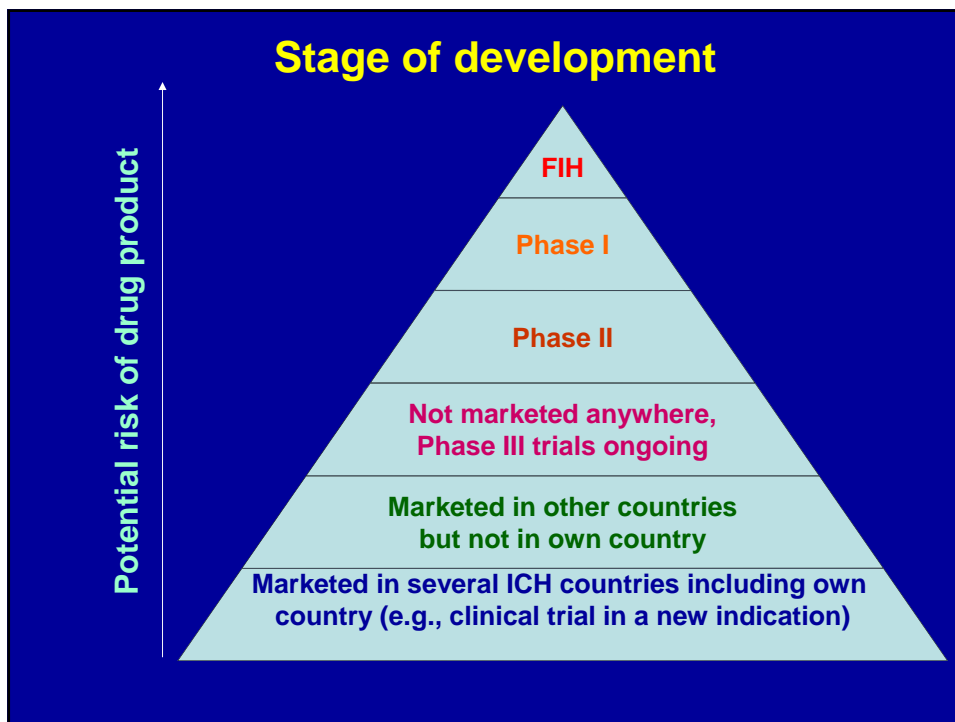

## Disease Target

- Morbidity and mortality of the disease
- Prevalence of the disease
- Availability of current therapies
- Current clinical practice guidelines
- Potential for exaggerated pharmacodynamic effects

## Subject Population

- Healthy adults
- Adult patients
- Pharmacogenomic subpopulation
- Elderly patients
- Pregnant women
- Pediatric
- Vulnerable patients

## Drug Product Type or Class

- Route of administration: oral, intravenous, intramuscular, subcutaneous, inhalation, intranasal, topical (local or systemic)
- Pharmaceutical, biologic, radiopharmaceutical: is it a novel class of drug substance/product? (e.g., nanosuspension, oligonucleotide, gene therapy)
- Potential risks with drug product or class, such as:
  - immunogenicity (e.g., PRCA)
  - hypersensitivity
  - human-sourced excipients (e.g., risk of BSE, viruses, etc.)
  - immunosuppression
  - birth defects
  - QT-prolongation
  - drug-dependence
  - liver toxicity
  - other...

## Sponsor

- Large pharmaceutical company
- Small pharmaceutical or biotech
- Domestic or international
- Academic

*Protection of clinical trial participants always prevails, regardless of who the sponsor is*



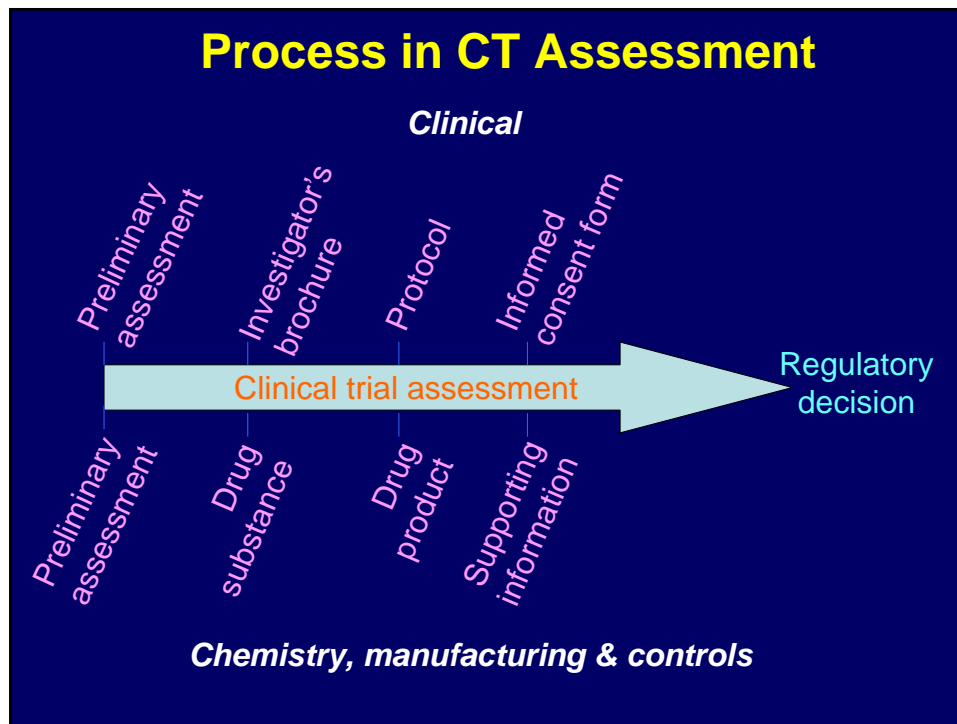

Therapeutic Products Directorate      Direction des produits thérapeutiques

## Chemistry, Manufacturing, and Controls

- Drug substance
- Drug product
- Impurities
- Manufacturing facilities
- Manufacturing process
- Quality control
- Supporting information

## Drug Substance

- Nomenclature & chemistry
- Manufacture
- Characterization
- Impurities
- Control of drug substance
- Container closure system
- Stability

## Drug Product

- Description and composition
- Pharmaceutical development
- Manufacture
- Control of excipients (e.g., human or animal origin)
- Control of drug product
- Container closure system
- Stability

## Clinical

- Investigator's brochure
- Protocol
- Informed consent form

## Investigator's Brochure

- Sufficient information on the following, as applicable:
  - Affinity/activity at target
  - Pharmacological activity in disease models
  - Pharmacokinetics, pharmacodynamics, and drug metabolism in two animal species
  - *In vitro* metabolism using human liver microsomes
  - Single and repeat dose toxicity and toxicokinetics in two animal species, one rodent and one non-rodent
  - Genotoxicity
  - Safety pharmacology (cardiovascular, CNS, respiratory)
  - Reproductive toxicity
  - Immunotoxicity
  - Local tolerance
  - Carcinogenicity
  - Clinical studies in humans, if available

## Protocol

- Rationale
- Study design & objectives
- Population & sample size
- Drug dosage regimen and administration
- Eligibility criteria
- Study procedures and assessments
  - Safety variables
  - Efficacy variables
- Risk mitigation measures
- Subject withdrawal and trial discontinuation criteria
- Statistical analysis

## Informed Consent Form

- Ensure that the following are adequately explained:
  - Objectives of the trial, number of subjects and duration of the trial
  - Trial procedures and subject's responsibilities
  - Aspects that are experimental
  - Potential risks and anticipated benefits
  - Other available therapies
  - Medical records may be accessed by regulatory authorities
  - Subject's participation in the trial is voluntary and subject may refuse to participate or withdraw at any time

## To Arrive at the Regulatory Decision

- Approach the CT application with **Safety** as the foundation
- Use a systematic, step-by-step approach, integrating all information submitted in the CT application and other information that is available publicly
- Quality is linked to clinical and clinical is linked to quality
- Identify any major gaps, and seek resolution through discussion with the sponsor
- On a case-by-case basis, there can be flexibility in data requirements as long as safety is preserved
- Ensure that the decision is science/evidence-based

## For a Positive Regulatory Decision

- ***Both*** CMC and clinical components comply with:
  - Regulatory requirements
  - Quality standards, as applicable
  - Acceptable risk mitigation measures in quality and clinical aspects
  - Commitments requested by regulator
- *Societal benefit from the trial is considered to outweigh the risks to clinical trial subjects*

L1

 Health Canada Santé Canada

**Therapeutic Products Directorate** **Direction des produits thérapeutiques**

Health Products and Food Branch Direction générale des produits de santé et des aliments

**4.2 – Concept of Benefit / Risk**

**Presentation to APEC Preliminary Workshop on Review of Drug Development in Clinical Trials**

**Celia Lourenco, PhD,  
Manager, Clinical Group I  
Office of Clinical Trials  
Therapeutic Products Directorate**





Therapeutic Products Directorate Direction des produits thérapeutiques

*Disclaimer: the information within this presentation is based on the presenter's expertise and experience, and represents the views of the presenter for the purposes of a training workshop*

## Slide 1

---

L1

Lourenco, 28/01/2551

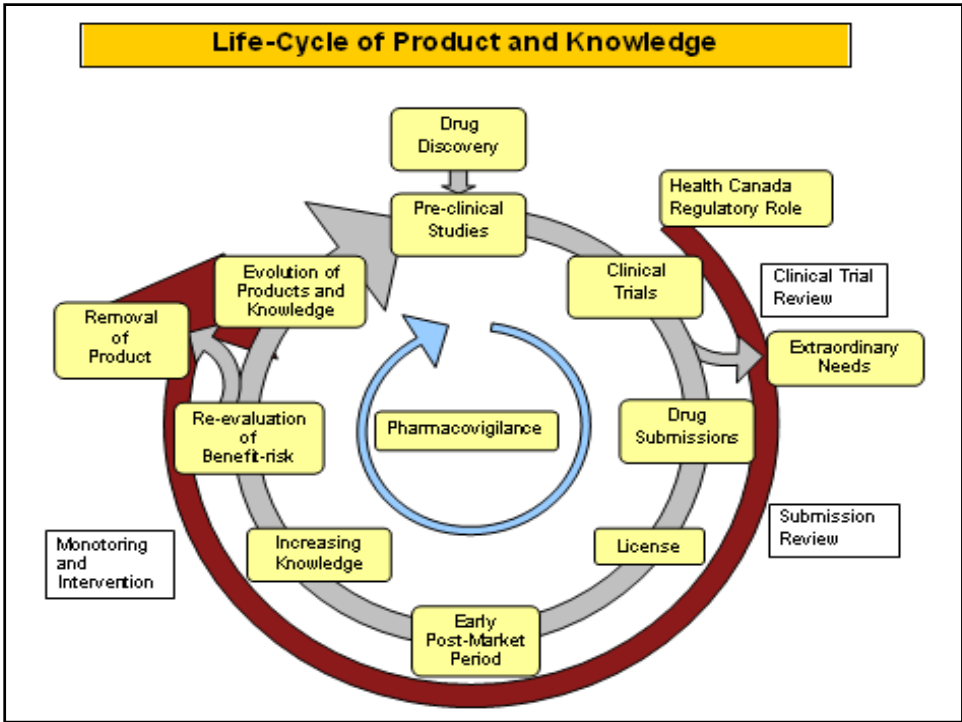
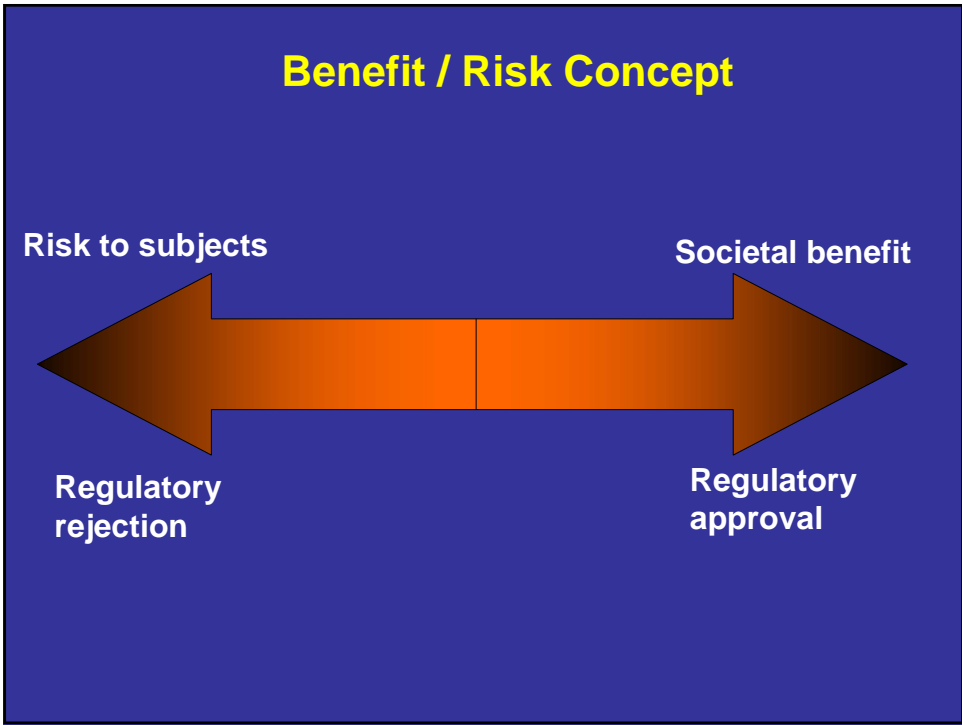



## Benefit / Risk

- Assessing benefit / risk involves:
  - Analysis of unmet medical need and disease characteristics
  - Analysis of data accumulated through product development
- Both the regulator and the sponsor assess benefit / risk continuously

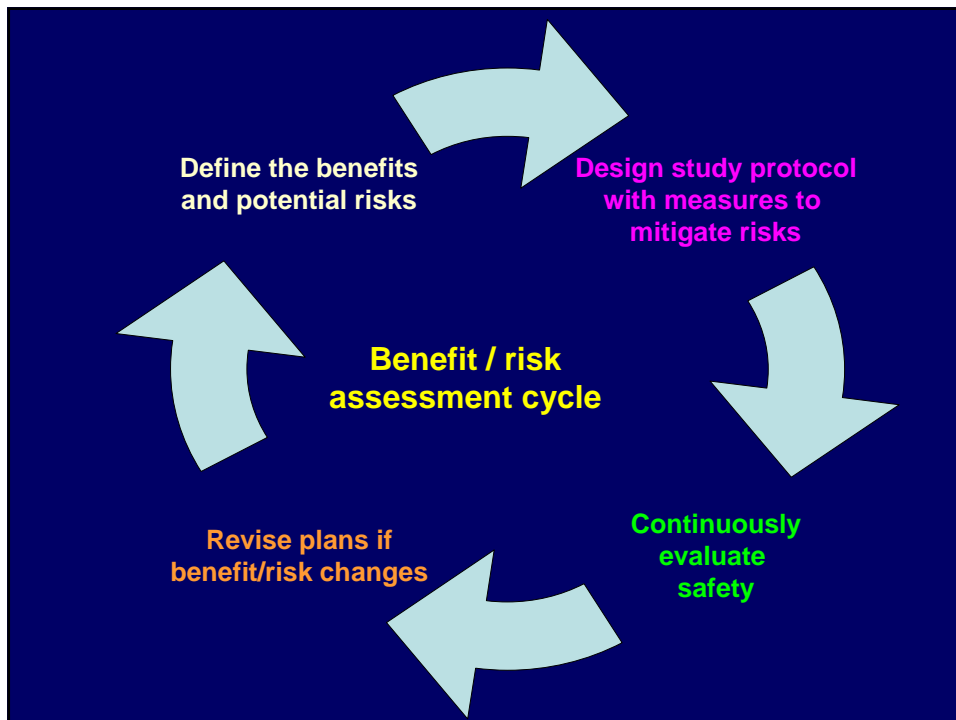

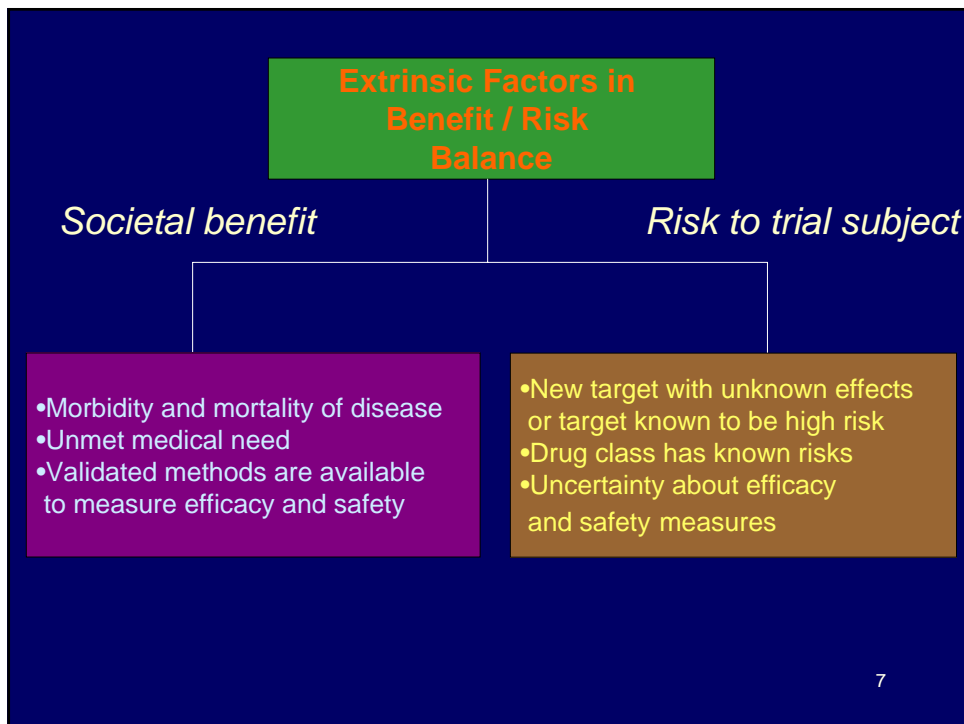

Therapeutic Products Directorate
Direction des produits thérapeutiques

## Benefit / Risk – Phase I (1)

- Healthy volunteers:
  - Benefits: societal benefit only (monetary benefit is not taken into account in regulatory decision)
  - What are the risks?
    - Drug type and target
    - Drug product quality
    - Potential toxicity based on pre-clinical studies
    - Proposed starting dose and dose-escalation method
    - Route of administration
    - Single vs repeat-dose
    - Sample size
    - Tests and procedures
  - What are the risk mitigation measures?

## Benefit / Risk – Phase I (2)

- Patients:
  - Benefits: societal benefit; potential for patient benefit in some studies
  - What are the risks?
    - Patient population
    - Drug type and target
    - Drug product quality
    - Potential toxicity based on pre-clinical studies
    - Proposed starting dose and dose-escalation method
    - Route of administration
    - Single vs repeat-dose
    - Sample size
    - Tests and procedures
- What are the risk mitigation measures?

## Benefit / Risk – Phase II

- Benefits: societal benefit; potential benefit to trial subjects
- What are the risks?
  - Patient population
  - Potential toxicity based on pre-clinical studies
  - Safety data from phase I studies
  - Changes in drug product quality
  - Proposed phase II starting dose and dose-range
  - Study design and endpoints
  - Duration of trial
  - Sample size
  - Tests and procedures
- What are the risk mitigation measures?

## Benefit / Risk – Phase III

- Benefits: societal benefit; potential benefit to trial subjects
- What are the risks?
  - Patient population
  - Safety data from phase I & II studies
  - Changes in drug product quality
  - Proposed dose or dosage regimen
  - Study design and endpoints
  - Statistical plan
  - Duration of trial
  - Tests and procedures
- What are the risk mitigation measures?

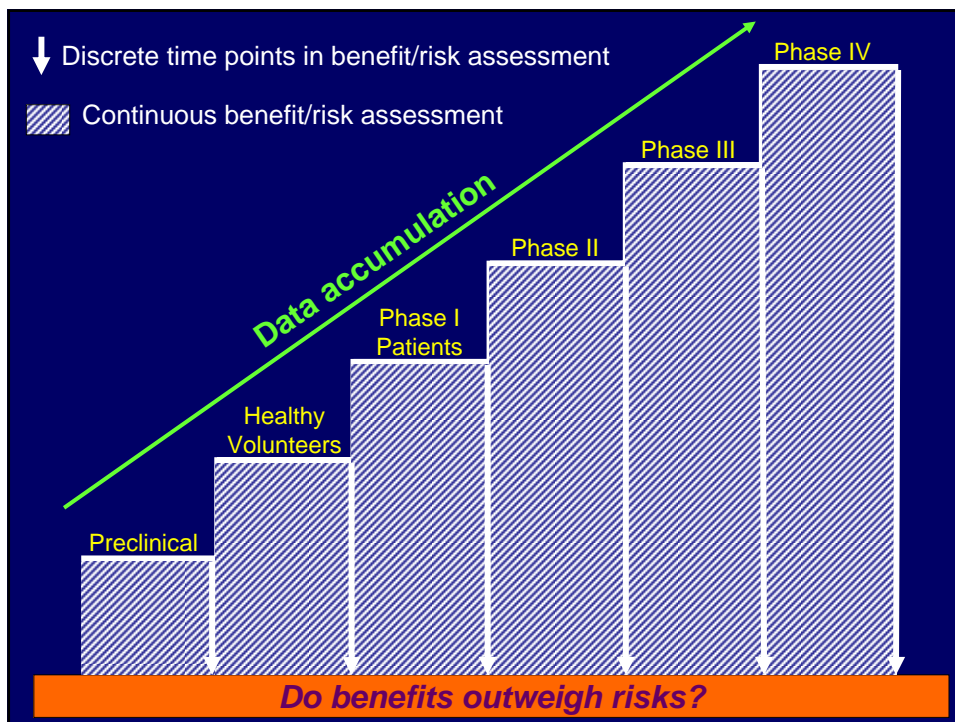

## Real World

- Previous trials often not conducted in own region
- Use of a comparator product not marketed in own region but marketed in another region
- Multiple investigational products
- Manufacturing changes in between phases (e.g., impact on more complex products such as biologics)
- Reconciling differences in clinical practices between regions
- Reconciling differences in marketing requirements between regions

## Conclusion

- The outcome of the benefit / risk assessment is a ***judgement call*** that is based on:
  - Extrinsic factors:
    - Morbidity and mortality of the disease
    - Extent of unmet medical need
    - Availability of validated safety & efficacy measures
    - Knowledge about the drug target and drug class
    - Marketing requirements
  - Factors related to the drug and the trial:
    - All accumulated data on the drug product
    - The proposed trial itself (e.g., design, population, dosage regimen, safety and efficacy measures, risk mitigation measures, etc.)
    - Adequate risk communication to trial subjects

## References

The Progressive  
Licensing  
Framework

[http://www.hc-sc.gc.ca/dhp-mps/prodpharma/activit/consultation/proglic\\_homprog\\_concept\\_e.html](http://www.hc-sc.gc.ca/dhp-mps/prodpharma/activit/consultation/proglic_homprog_concept_e.html)

L1

 Health Canada Santé Canada

**Therapeutic Products Directorate** **Direction des produits thérapeutiques**

Health Products and Food Branch Direction générale des produits de santé et des aliments



**4.3 – Qualification Expertise (Canada)**

**Presentation to APEC Preliminary Workshop on Review of Drug Development in Clinical Trials**

**Celia Lourenco, PhD,  
Manager, Clinical Group I  
Office of Clinical Trials  
Therapeutic Products Directorate**



 Therapeutic Products Directorate Direction des produits thérapeutiques

*Disclaimer: the information within this presentation is based on the presenter's expertise and experience, and represents the views of the presenter for the purposes of a training workshop*

## Slide 1

---

L1

Lourenco, 28/01/2551



## Overview

- Organizational structure (OCT as a model)
- Personnel duties and qualifications
- Training & continuing education
- Recruitment & retention

### Pharmaceuticals

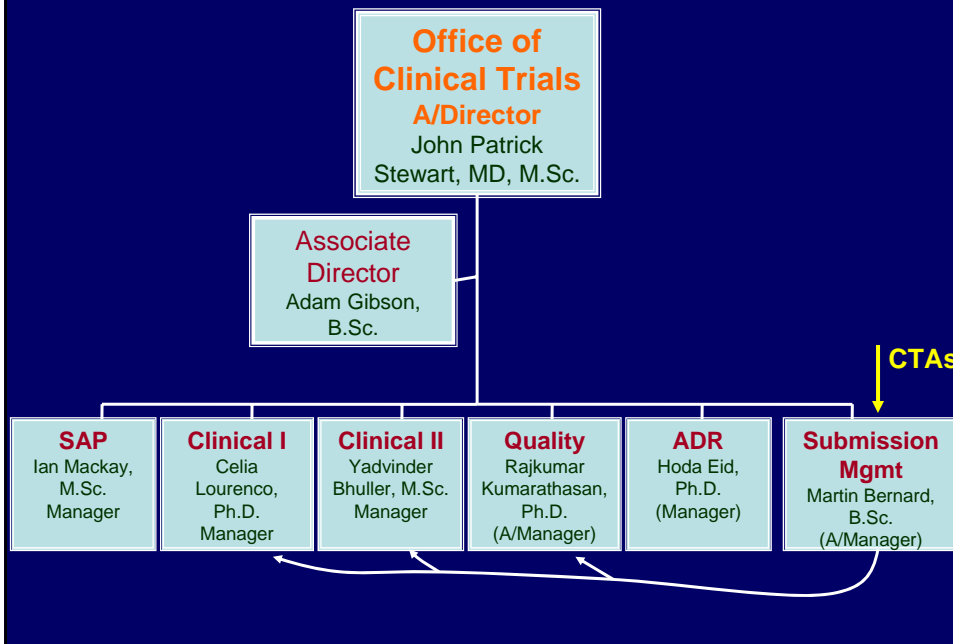

## Personnel

- Screening and Information Officers
- Assessment Officers
  - Clinical
  - Chemistry
- Managers
- Administrative Staff

## Screening and Information Officers

- **Duties:**
  - Screen clinical trial applications to ensure that all required documents have been submitted and are complete
  - Communicate with sponsors to address deficiencies
  - Issue acknowledgement letters and screening deficiency notices
  - Lead or contribute to the development of regulations, policies, guidelines
- **Education:** B.Sc. in pharmacy, microbiology, chemistry, or another biomedical science
- **Knowledge:** Regulations, drug approval process, drug submission process and related policies
- **Abilities:** communicate effectively orally and in writing, prioritize, analyse information and make recommendations, and work effectively on a team

## CMC Assessment Officers (1)

- **Duties:**
  - assess the quality, chemistry, and manufacturing component of clinical trial applications
  - Communicate with sponsors to address deficiencies
  - Make recommendations on approval/rejection of applications
  - Lead or contribute to the development of regulations, policies, guidelines
- **Education:** minimum a B.Sc. (M.Sc. or higher is preferred especially for biologics) in chemistry, analytical chemistry, pharmaceutical chemistry, biotechnology, biology, or biochemistry
- **Experience in:**
  - conduct of scientific research
  - application of pharmaceutical/biologic manufacturing and analytical procedures

## CMC Assessment Officers (2)

- **Knowledge of:**
  - Regulations and guidelines
  - Pharmaceutical/biologic manufacturing and analytical procedures
  - project management practices
- **Abilities:**
  - Ability to analyze and evaluate scientific and regulatory issues, and subsequently prepare formal reports for senior management containing effective recommendations
  - Ability to lead and coordinate the activities of project teams or working groups
  - Ability to work under pressure with frequent changes in plans and conflicting priorities
  - Ability to communicate effectively orally and in writing

## Clinical Assessment Officers (1)

- **Duties:**
  - Assess the clinical component of clinical trial applications
  - Communicate with sponsors to address deficiencies
  - Make recommendations on approval/rejection of applications
  - Lead or contribute to the development of regulations, policies, guidelines
- **Education:** Ph.D. in pharmacology, toxicology, immunology, molecular biology, biochemistry or another biomedical science related to the duties of the position or Medical Doctor in any specialization; Medical Doctors may have foreign training but degree must be assessed against Canadian education standards
- **Experience in:**
  - Conduct of scientific research
  - Evaluation of, and preparation of critical reviews on, biomedical / scientific data

## Clinical Assessment Officers (2)

- **Knowledge of:**
  - Regulations and guidelines
  - Therapeutic product development process and the corresponding assessment of quality, safety and efficacy
  - Monitoring and evaluation methodologies
  - Benefit / risk assessment for therapeutic products
  - Therapeutic areas related to the function of the position
- **Abilities:**
  - Analyze, evaluate and summarize scientific data
  - Prepare detailed scientific reports and recommendations
  - Work independently and in teams
  - Communicate effectively orally and in writing
  - Plan, organize and manage projects
  - Recognize the need for and develop new methodologies or adapt existing methodologies in the evaluation of therapeutic products

## Managers (1)

- **Duties:**
  - Manage the processing and review of clinical trial applications
  - Ensure advice, recommendations, and decisions are supported by the regulations, and are consistent
  - Lead meetings with sponsors
  - Lead or contribute to the development of regulations, policies, guidelines
  - Ensure skills and competencies are maintained / enhanced within the division
- **Education:** B.Sc. minimum for submission screening manager; generally Ph.D. or M.D. for assessment divisions
- **Experience:** significant recent experience in the regulatory evaluation of products within the framework of the regulations

## Managers (2)

- **Knowledge of:**
  - Regulations, policies and guidelines related to the review and evaluation of drug submission in Canada
  - Principles, conduct and evaluation of clinical trials including biostatistics and toxicological testing of drugs (clinical stream)
  - Scientific principles and theories related to the assessment of quality of pharmaceutical/biologic drug products (CMC stream)
- **Abilities:**
  - Communicate effectively and clearly, orally and in writing
  - Provide critical analysis of scientific data and scientific advice to senior management as well as external stakeholders in an effective manner
  - Plan and co-ordinate work to meet deadlines

## Administrative Staff

- **Duties:**
  - Administrative support for all technical staff in the processing and review of applications
  - Entry of data on databases and preparation of application tracking forms
  - Interface with sponsors
- **Education:** high-school diploma
- **Knowledge** of general office practices and procedures
- **Abilities:**
  - Evaluate and track information and determine appropriate action to be taken
  - Prepare correspondence and maintain a correspondence database
  - Make travel arrangements
  - Organize and coordinate meetings
  - Work under pressure with a constant changing environment
  - Meet schedules and deadlines

## Personal Suitability for all Personnel

- Effective interpersonal skills
- Initiative
- Leadership
- Dependability
- Thoroughness
- Accuracy
- Judgement
- Tact
- Respective of diversity

## Training & Continuing Education

- Orientation packages
- SOP for clinical trial application reviews
- Assign mentors
- Progressive increase in the difficulty of work assigned
- Courses offered through Health Canada continuing education office
- Access to journal publications and books through Health Canada library system
- Attendance at local and international conferences
- Culture of “team environment” where continuous discussion and consultation is encouraged

## Recruitment & Retention

- Public Service Employment Act
- Standardized selection processes
  - Develop essential criteria for each position
  - Advertise internally and externally (i.e., web sites)
  - Conduct written exams, oral interviews, reference checks, evaluation of language proficiency
- Retention:
  - Pay commensurate with similar professions / positions with high responsibility and accountability
  - Training opportunities and support
  - Morale and recognition



## 4.3 Qualification Expertise in Japan

Junko Sato, PhD

Review Director, Office of New Drug I



## Disclaimer

- ◆ *The information within this presentation is based on the presenter's expertise and experience, and represents the views of the presenter for the purposes of a training workshop*



# Organization of PMDA

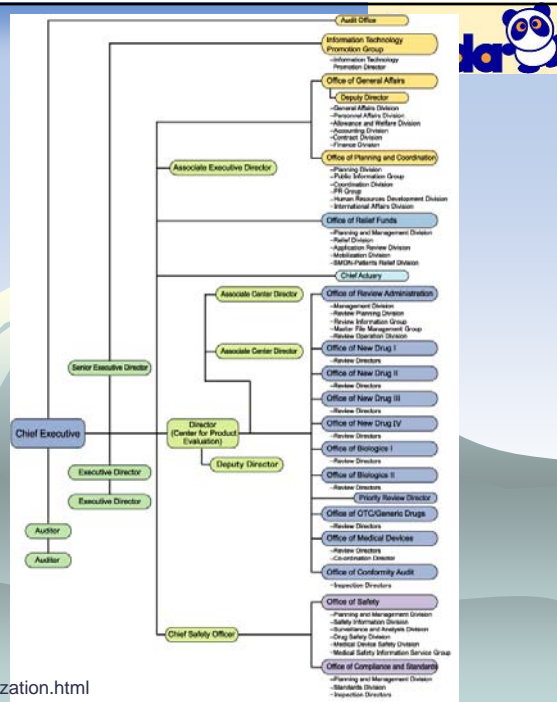

<http://www.pmda.go.jp/english/about/organization.html>

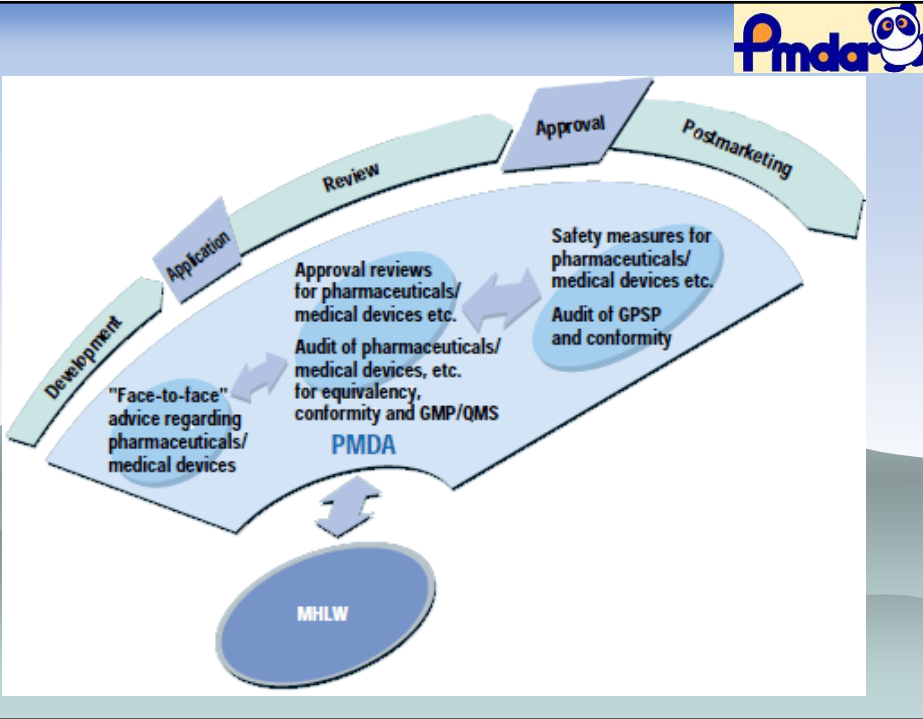

## Comparison of Number of Reviewer, Fees

	Japan 2003	Japan 2008 (prospect)	US	UK (Drugs only)	France	EMEA
Number of reviewer	183	292 <small>IAA inspection Safety operation</small>	2,600	436	950	248
Application fee, etc	3.4 <small>billion-yen</small>	7.3** <small>billion-yen</small>	32 <small>billion-yen</small>	6.6 <small>billion-yen</small>	6.7 <small>billion-yen</small>	10.2 <small>billion-yen</small>

\* Total of MHLW HQ, PMDA, \*\* Total of Application fee and contribution

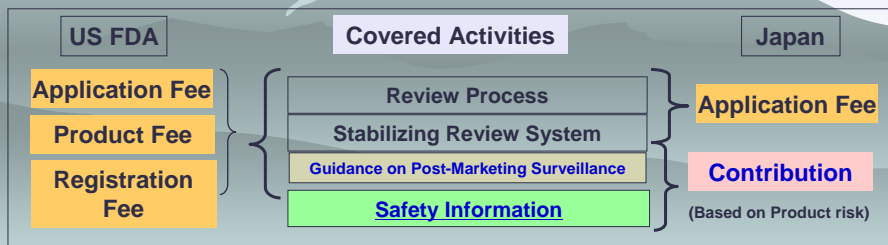

## 3 major Operations

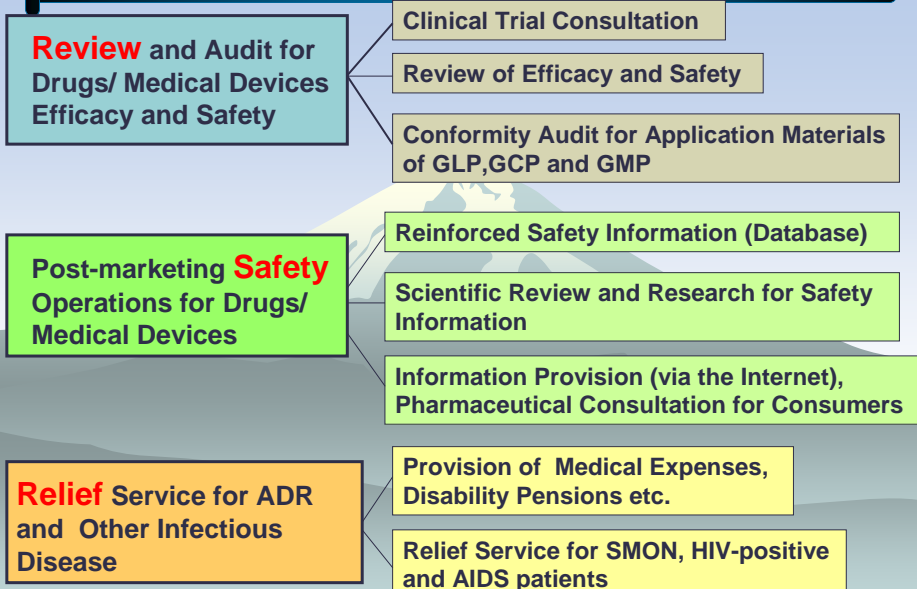



# NDA Evaluation in PMDA

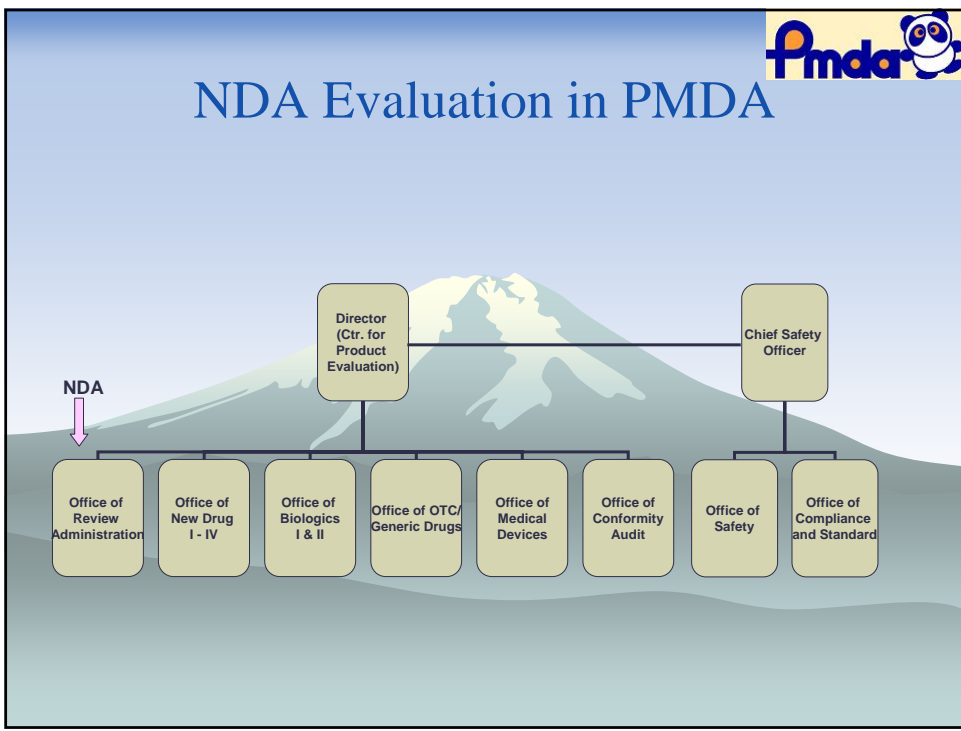

# Organization of Office

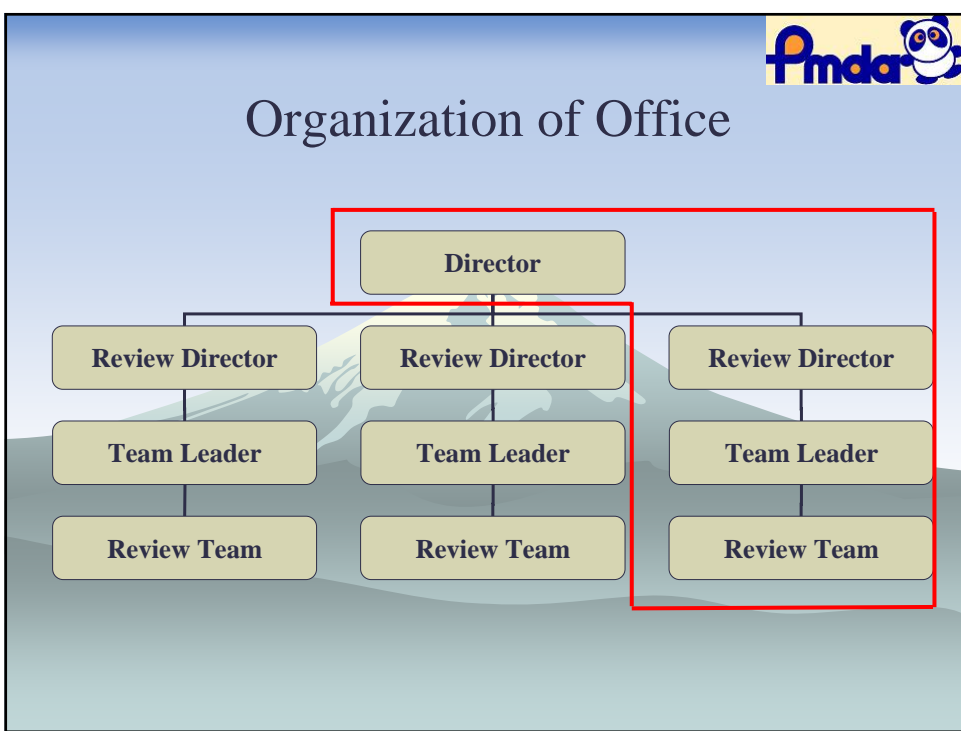

## Team Member



CMC	Pharmacol.	ADME	Tox.	Clin.	Statistician
1	1	1	2	2-3	1-2
Pharmacist			Veterinary	MD	Bio Statistician

## Reviewers

- ◆ **Education** : PhD, MS or MD(Dent.D) is required.
- ◆ **Knowledge** : Current science, regulations, review process, etc.
- ◆ **Abilities** : Communication, make recommendation to consultation & review, English

## Previous post

- ◆ Academia
  - ❖ Research, teach etc.
- ◆ Pharmaceutical Industries
  - ❖ Research, clinical development etc.
- ◆ Students

## 'Career Path' in PMDA (in developing)

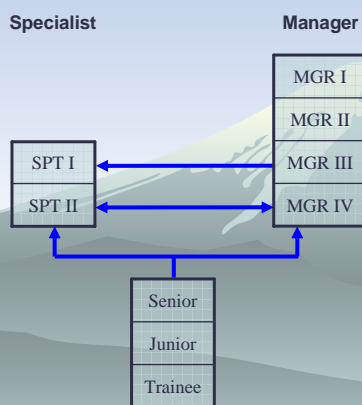

Grade	Requirements
MGR I	Executive Director, Executive Director, Chief Safety Officer etc.
MGR II	Associate Center Director
MGR III	Office Director
MGR IV	Manage review team and resolve problems between teams, Make decisions as a review team, Advises to team and reviewers, manages communication between team and sponsors, contribute to develop guidelines and policies (Review Director, Associate Director etc.)
SPT I	Advises from extremely advanced expertise, and bears improvement of judgment, personnel training, knowledge, and technical level, supervise SPT II
SPT II	Contributes to teams by knowledge and improvement of technical level based on advanced expertise
Senior	Recommend to review and Consultation with high level acknowledgements, analyze and judge review process
Junior	Contributes to typical and atypical review and consultation with intermediate level acknowledgements
Trainee	Contributes to typical review and consultation under supervise

## Manager ? Specialist ?

- ◆ What are difference ?
  - ❖ Manager
    - ◆ Contribute to all job by general consideration
  - ❖ Specialist
    - ◆ Contribute to job by specialty (cf. CMC, ADME, etc.)

## Recruitment and Retention

- ◆ To increase reviewers,
  - ❖ Introduce our job in universities
  - ❖ Advertisement on Science Journal
  - ❖ Presentation on our job in scientific conference
- ◆ For retention,
  - ❖ Make path of reviewers clear
  - ❖ Keep incentive

## Training for reviewers in PMDA

### ◆ Training

#### ❖ Review Skills

- ◆ Basic process/Legislation
- ◆ Case studies
- ◆ Scientific Seminar

#### ❖ IT skills

- ◆ Review Database
- ◆ Word etc.

#### ❖ Writing Skills

- ❖ Communication skills etc.



**Thank you for your attention !**

L1

 Health Canada Santé Canada

**Therapeutic Products Directorate** **Direction des produits thérapeutiques**

Health Products and Food Branch Direction générale des produits de santé et des aliments

**5 – Quality (CMC) considerations**

**Presentation to APEC Preliminary Workshop on Review of Drug Development in Clinical Trials**

**Celia Lourenco, PhD,  
Manager, Clinical Group I  
Office of Clinical Trials  
Therapeutic Products Directorate**





Therapeutic Products Directorate Direction des produits thérapeutiques

*Disclaimer: the information within this presentation is based on the presenter's expertise and experience, and represents the views of the presenter for the purposes of a training workshop*



Slide 1

---

L1

Lourenco, 28/01/2551

## Overview

- Objective in the assessment of quality
- CMC framework
- Summary of quality (CMC) requirements and some deficiencies frequently encountered
- Guidance documents and templates
- Exercise

## Overarching Objective

Ensure that trial subjects are not placed at risk, and that the results of clinical trials are unaffected by inadequate safety, quality or efficacy arising from unsatisfactory manufacture

## CMC Framework for Clinical Trials

- Schedule B provides a list of Pharmacopoeias
- Division 5: CMC information in respect of the drug is required in a CT application
- Annex 2 to GMP available for reference but manufacturers not inspected
- ICH guidelines available for reference but considered of greater importance at the marketing stage
- Post-approval requirements (e.g., lot-release program for biologics)

## Schedule B to the Food and Drugs Act

- European Pharmacopoeia (Ph.Eur.)
- Pharmacopée française (Ph.F.)
- Pharmacopoeia Internationalis (Ph.I.)
- The British Pharmacopoeia (B.P.)
- The Canadian Formulary (C.F.)
- The National Formulary (N.F.)
- The Pharmaceutical Codex: Principles and Practices of Pharmaceuticals
- The United States Pharmacopoeia (U.S.P.)

## GMP for Drugs in Clinical Trials

- Interpretation of Division 2 of the regulations is in Annex 2 to the GMP
- Adapted from the Pharmaceutical Inspection Cooperation Scheme Annex 13: “Manufacture of Investigational Medicinal Products” to meet Canadian requirements

## GMP Considerations

- Production of investigational drugs involves added complexity in comparison to marketed drugs due to:
  - lack of fixed routines
  - variety of clinical trial designs and consequent packaging designs
  - the need for randomization and blinding
  - increased risk of product cross-contamination and mix up
  - incomplete knowledge of the potency and toxicity of the product
  - lack of full process validation
  - marketed products may be used which have been re-packaged or modified in some way

## GMP Annex 2 Content

- Quality management
- Personnel
- Premises and Equipment
- Documentation
- Production
- Quality control
- Release of batches
- Shipping
- Complaints
- Recalls and returns
- Destruction

## Preliminary Considerations

Use a benefit/risk approach in the evaluation of quality:

- What is the phase of trial and stage of development?
- Link between quality and clinical: what is the intended use of the product?
- Is product type / class known to have quality concerns?
- What is the level of experience of the manufacturer?

## CMC Assessment in Clinical Trials

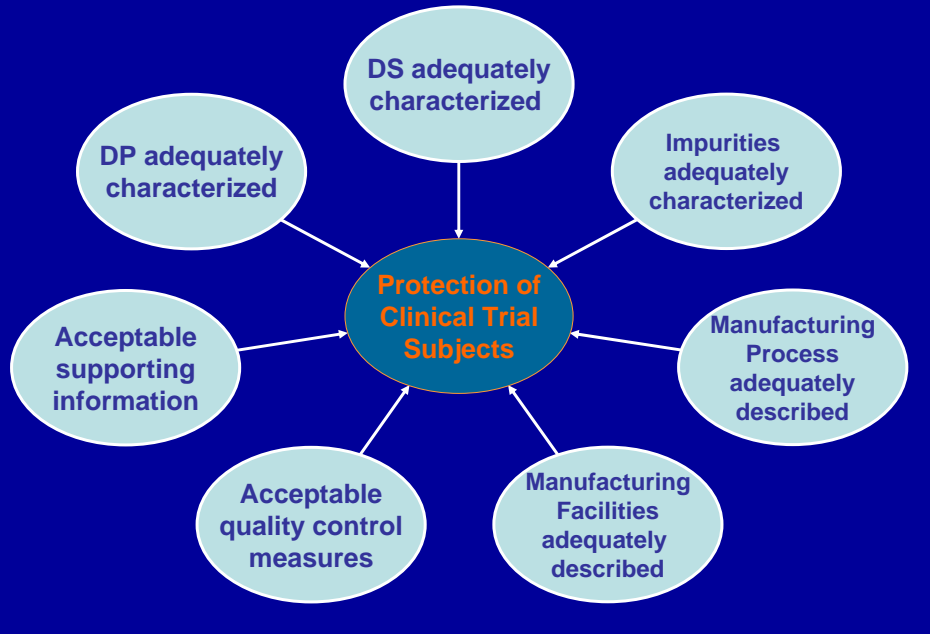

## CMC Data Requirements: Pharmaceuticals

## Introduction

- Summary of product information
- Excerpt from protocol synopsis
- Information on the comparator product
- Information for cross-referencing sections to previous submissions

## Drug Substance

### **General Information:**

- Nomenclature (INN, compendial name, chemical name, company code, other non-proprietary name(s), CAS number)
- Structure (structural formula, molecular formula, molecular mass)
- General Properties: physical description, physical form (polymorphic form, solvate, hydrate), solubilities, pH & pKa

## Manufacture

- Manufacturers: name and addresses of sites involved in the manufacture of clinical batches of drug substance, DMF numbers
- Description of the Manufacturing Process and Controls: flow diagram and narrative description of the synthesis
- Control of Materials: information for drug substances from sources at risk of transmitting BSE/TSE

## Characterization

### Elucidation of Structure and other Characteristics:

- Evidence of structure (e.g., IR, UV, NMR, MS, elemental analysis)
- Discussion on the potential for isomerism and identification of stereochemistry
- Summary of studies on polymorphic forms
- Summary of particle size distribution studies



## Impurities

- Drug-related impurities (including chemical name, structure and origin)
- Process-related impurities (solvents, reagents)
- Actual levels of impurities found in clinical batches

## Control of Drug Substance

- Specifications, including tests, type of analytical procedures, and acceptance criteria (phase II/III)
- Batch analysis: description of batches to be used in the trial (batch no., batch size, date and site of production), and summary of results

## Container Closure System & Stability

- **Container Closure System:**
  - Description of the container closure system(s) for the storage and shipment of the drug substance
- **Stability:**
  - Stability Summary and Conclusions (summary of studies to support the clinical trial)
  - Post-approval Stability Protocol and Stability Commitment: if full long term data is not available at the time of filing, provide the stability protocol and a commitment for the continued monitoring of the drug substance stability according to the protocol
  - Summary of raw data (reference to volume)

## Drug Product Description & Composition

- Description of the dosage form
- Composition of the dosage form (list of components and amounts, composition of mixtures)
- Description of reconstitution diluent(s), if applicable
- Qualitative composition of placebo (phase II/III)

## Pharmaceutical Development

- Discussion on development of the dosage form, the formulation and manufacturing process (Phase II/III)
- For sterile, reconstituted products, summary of compatibility studies with diluents / containers

## Drug Product - Manufacture

- Manufacturers: name and addresses of sites involved in the manufacture of clinical batches of drug product, DMF numbers
- Batch Formula
- Description of manufacturing process and process controls: flow diagram, narrative description, sterilization / lyophilization conditions for sterile products

## Control of Excipients (1)

### Specifications:

- Specifications for non-compendial excipients and for compendial excipients with supplementary tests not listed in the monograph(s)
- Confirmation that none of the excipients which appear in the drug product are prohibited for use in drugs by the Canadian *Food and Drug Regulations* (e.g., chloroform, arsenic)

## Control of Excipients (2)

### Excipients of human or animal origin:

- List of excipients that are of human or animal origin
- Summary of the information regarding adventitious agents for excipients of human or animal origin
- For excipients obtained from sources that are at risk of transmitting BSE/TSE agents, a letter of attestation (with supporting documentation) should be provided confirming that the material is not from a BSE/TSE affected country/area

## Control of Excipients (3)

### Novel Excipients:

- Summary of the details on the manufacture, characterization, and controls, with cross references to supporting safety data (non-clinical and/or clinical) on novel excipients (i.e., those used for the first time in a drug product or by a new route of administration)

## Control of Drug Product

### Specifications:

- Specifications for the drug product: tests, type of analytical procedure, acceptance criteria (Phase II/III)
- Batch analysis: batch no., batch size, data and site of production for clinical batches, and summary of results

### Characterisation of impurities:

- Information on the characterisation of impurities, not previously provided in the drug substance impurities section (e.g., summary of actual and potential degradation products)

## Container Closure System

- Description of the container closure system, including unit count or fill size, container size or volume
- Materials of construction of each primary packaging component
- For sterile products, details of washing, sterilization and depyrogenation procedures for container closures

## Stability

- Stability summary and conclusions:
  - Summary of studies to support the clinical trial (batch numbers, conditions, packaging, etc.)
  - Summary and discussion of results
  - Proposed storage conditions and shelf life
- Post-approval stability protocol and stability commitment: if full long term data is not available at the time of filing, the stability protocol should be provided with a commitment to monitor the clinical trial samples throughout the duration of the trial or the proposed shelf life
- Raw stability data (reference to submission volume)

## CMC Considerations for Biologics

### Issues

- Complexity of manufacturing process, drug substance, and drug product
- Added difficulty in control of drug substance and drug product, including impurities
- Additional potential risks associated with:
  - host cell contaminants derived from bacteria, yeast, insect, plants, and mammalian cells
  - host contaminants can result in allergic reactions and other immunopathological effects
  - nucleic acid contaminants have the potential for integration into the host genome
  - additional risk of viral infections for products derived from insect, plant and mammalian cells, or transgenic plants and animals

## Key Requirements (1)

- Information on raw materials, especially materials of biological origin (e.g., cell banks, albumin, enzymes, fetal calf serum, human plasma)
- Control and removal of adventitious agents (e.g., viruses, prions, bacteria)
- Endotoxin control
- Sterility of finished product, especially for aseptically-filled products

## Key Requirements (2)

- Demonstration of knowledge of the active pharmaceutical ingredient (API):
  - Characterization of the API
  - Understanding of impurities
    - Process-related: objectional impurities such as solvents, heavy metals, aggregates, etc.
    - Product-related: intrinsic to the product but can be problematic since they can be significantly more or less active or may be more immunogenic (e.g., oxidized, clipped, deamidated impurities)
- Demonstration of understanding of the manufacturing process



## Key Requirements (3)

- **Specifications:**
  - Should be appropriate to control the clinical trial product to the stage of development to ensure safety and quality
- **Stability:**
  - Long-term
  - Accelerated
  - In-use (for multi-use products)
- **Case-specific issues:**
  - Novel excipients

## Additional Considerations (1)

- As the drug product progresses through development, changes normally occur in the manufacturing process in order to improve product quality and yields
- The potential impact of such changes for extrapolation of pre-clinical data or earlier clinical trials to later development clinical trials, should be considered
- The comparability of the test material during a development program should be demonstrated when a new or modified manufacturing process or other significant changes in the product or formulation are made in an ongoing development program

## Additional Considerations (2)

- Comparability can be evaluated on the basis of biochemical and biological characterisation (i.e., identity, purity, stability, and potency)
- In some cases additional studies may be needed (i.e., pharmacokinetics, pharmacodynamics and/or safety)
- The scientific rationale for the approach taken should be provided
- Overall, the goal is to demonstrate that improvements in processes lead to improvements in product quality while preserving or improving safety

## Unique requirements for Radiopharmaceuticals

- Radioactive nature of the drug substance and/or drug product impacts on CMC requirements
- Radioactive dose range
- For kits, expiry time/date, storage conditions, and stability data before and after reconstitution
- Information on radionuclide and decay characteristics
- Radionuclidic and radiochemical purity and impurity

## Key Messages in Quality Review

- Use a systematic approach where every component of the quality information contributes to the overall assessment
- Compare all drug substance and drug product batch results and look for variability, inconsistencies
- Ensure stability testing is adequate for the type of product and intended use
- Use a benefit / risk approach where other factors such as the phase of development, subject population, and manufacturer's experience contribute to the assessment
- CMC is expected to progress through product development phases
- Often involves a case-by-case judgement call on extent of quality data requirements at time of application or as a post-approval commitment

## Guidance Documents

- Quality (Chemistry and Manufacturing) Guidance: Clinical Trial Applications
- Preparation of the Quality Information for Drug Submissions in the CTD Format:
  - Conventional Biotherapeutic Products
  - Vaccines
  - Blood Products
  - Biotechnological Products

## Templates - Pharmaceuticals

- Quality Overall Summary - Chemical Entities (Clinical Trial Applications Phase I) (QOS-CE (CTA - Phase I))
- Quality Overall Summary - Chemical Entities (Clinical Trial Applications - Phase II/III) (QOS-CE (CTA - Phase II/III))
- Quality information for Phase II trials cannot be cross-referenced to the Quality information submitted with Phase I trials
- Quality information for Phase III trials cannot be cross-referenced to the Quality information submitted with Phase II trials

## Templates - Biologics

- QOS template is not available for biologics
- Manufacturers are advised to use the exact headings as indicated in the guidance documents
- Headings that have a  are applicable to clinical trial applications
- With subsequent CTA filings for the same drug (e.g. Phase II or III studies), where much of the quality information may be similar, the sponsor is encouraged to build upon the previously completed QOS (e.g. Phase I or II study), by making any necessary revisions or adding relevant information to update the submission and clearly identifying the changes using either coloured text or a different font

## References

Quality Guidance Documents	<a href="http://www.hc-sc.gc.ca/dhp-mps/alt_formats/hpfb-dgpsa/pdf/brgtherap/ctd_convbio_e.pdf">http://www.hc-sc.gc.ca/dhp-mps/alt_formats/hpfb-dgpsa/pdf/brgtherap/ctd_convbio_e.pdf</a> <a href="http://www.hc-sc.gc.ca/dhp-mps/alt_formats/hpfb-dgpsa/pdf/brgtherap/ctd_biotech_e.pdf">http://www.hc-sc.gc.ca/dhp-mps/alt_formats/hpfb-dgpsa/pdf/brgtherap/ctd_biotech_e.pdf</a> <a href="http://www.hc-sc.gc.ca/dhp-mps/alt_formats/hpfb-dgpsa/pdf/brgtherap/ctd_blood-sang_prods_e.pdf">http://www.hc-sc.gc.ca/dhp-mps/alt_formats/hpfb-dgpsa/pdf/brgtherap/ctd_blood-sang_prods_e.pdf</a> <a href="http://www.hc-sc.gc.ca/dhp-mps/alt_formats/hpfb-dgpsa/pdf/brgtherap/ctd_vacc_e.pdf">http://www.hc-sc.gc.ca/dhp-mps/alt_formats/hpfb-dgpsa/pdf/brgtherap/ctd_vacc_e.pdf</a> <a href="http://www.hc-sc.gc.ca/dhp-mps/alt_formats/hpfb-dgpsa/pdf/prodpharma/qual_cta_dec_e.pdf">http://www.hc-sc.gc.ca/dhp-mps/alt_formats/hpfb-dgpsa/pdf/prodpharma/qual_cta_dec_e.pdf</a>
Quality templates	<a href="http://www.hc-sc.gc.ca/dhp-mps/alt_formats/hpfb-dgpsa/pdf/prodpharma/qoscecta_sgqecdec_ph_i_e.pdf">http://www.hc-sc.gc.ca/dhp-mps/alt_formats/hpfb-dgpsa/pdf/prodpharma/qoscecta_sgqecdec_ph_i_e.pdf</a> <a href="http://www.hc-sc.gc.ca/dhp-mps/alt_formats/hpfb-dgpsa/pdf/prodpharma/qoscecta_sgqecdec_ph_ii_iii_e.pdf">http://www.hc-sc.gc.ca/dhp-mps/alt_formats/hpfb-dgpsa/pdf/prodpharma/qoscecta_sgqecdec_ph_ii_iii_e.pdf</a>
Annex 2: Manufacture of Drugs Used in Clinical Trials	<a href="http://www.hc-sc.gc.ca/dhp-mps/alt_formats/hpfb-dgpsa/pdf/compl-conform/clin_trials-essais_cln_e.pdf">www.hc-sc.gc.ca/dhp-mps/alt_formats/hpfb-dgpsa/pdf/compl-conform/clin_trials-essais_cln_e.pdf</a>

41

## Thank You!

## Questions?

42

## Exercise

- Drawing upon your experience, and if necessary, by reviewing the guidance documents provided to you for chemical entities and conventional biotherapeutics, discuss the following question in your groups.
  - Prepare a summary of your discussion and record your findings on the flip chart.
  - Chose a speaker who will present your findings to the entire group.
1. When is drug quality considered more important in the drug development process? When is it considered less important?

Time: 60 min

## Plenary discussion



## Phase I: Overview

**Namrata Bahadur**  
 Head of Clinical Development & Medical Affairs  
 Emerging Growth Markets  
 18<sup>th</sup> March, Bangkok

© 2008 Novartis

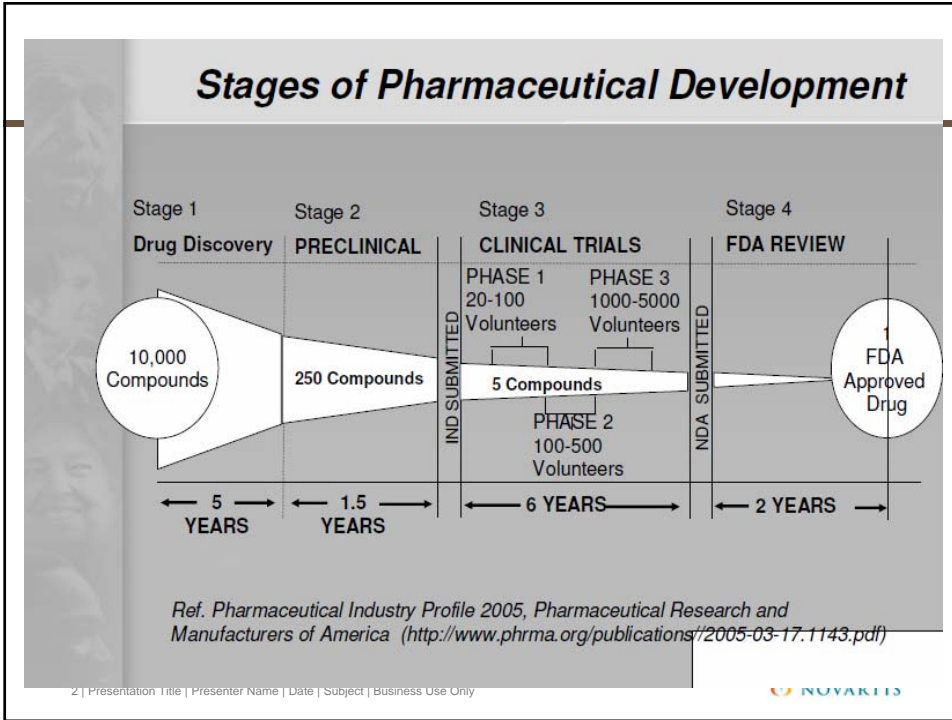

## Spectrum of "PoC"

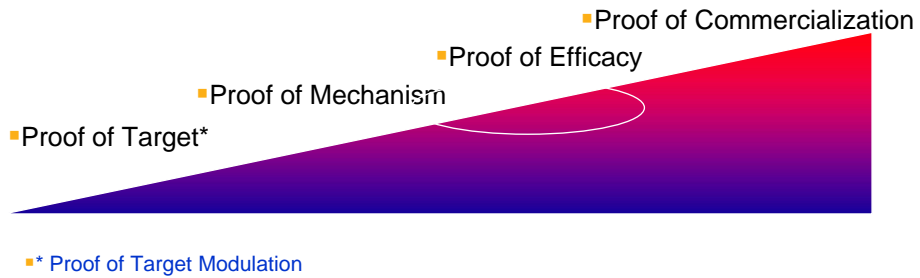

3 | Presentation Title | Presenter Name | Date | Subject | Business Use Only



•  
•  
•

## Where does PK play a role in Drug Development?

- **Pharmacokinetics is either directly or indirectly associated with just about every part of pharmaceutical business**
  - Research and the selection of a promising molecule
  - Dosage formulation development
  - Dose regimen
  - Toxicology and safety assessment
  - Dosing recommendations for age groups & sub-populations (renal/hepatic/race/DDI)
  - Effect of meals and dosing
  - Marketing claims and promotion
  - Generic substitution
  - Manufacturing changes

• • • • • • • •





## ***Drug Product Development Challenges for New Chemical Entities***

### **Formulation Issues**

- Poor aqueous solubility
- Poor physical and chemical stability
- Low permeability
- First-pass metabolism
- Poor bioavailability
- Short half life and duration of action
- Inappropriate dose

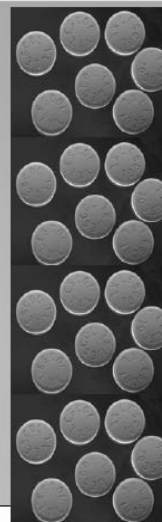

7 | Presentation Title | Presenter Name | Date | Subject | Business Use Only



## ***Drug Product Development Challenges for New Chemical Entities***

### **Formulation Issues**

- Invasive dosage forms (injections)
- Non-injectable formulations are usually poorly bioavailable and inefficient
- Stable only under frozen conditions (liquid forms) or low temperature (lyophiles at 2-8°C)
- Short duration of action for most proteins (non-mAbs)
- Need for prolonged release formulations



8 | Presentation Title | Presenter Name | Date | Subject | Business Use Only



## ***Drug Product Design Options: Conventional Dosage Forms***

### **Routes**

- **ORAL**
- **PARENTERAL**
- **INHALATION**
- **TOPICAL**
- **TRANSDERMAL**
- **OTHER**
  - BUCCAL/SUBLINGUAL
  - RECTAL
  - OPHTHALMIC
  - NASAL

### **Dosage Forms**

- Tablets, capsules, solutions
- Sterile s.c., i.m., i.v. injectables
- Pressurized multidose inhalers
- Creams, ointments, gels
- Patches (passive diffusion)

## ***Drug Product Design Options: Special Drug Delivery Systems***

### **What does a Drug Delivery System Do?**

- **Enhance absorption**
- **Control release**
- **Reduce variability**
- **Target systemic delivery**
- **Introduce mechanical devices, when necessary**
- **Increase patient convenience**
- **Better therapy**

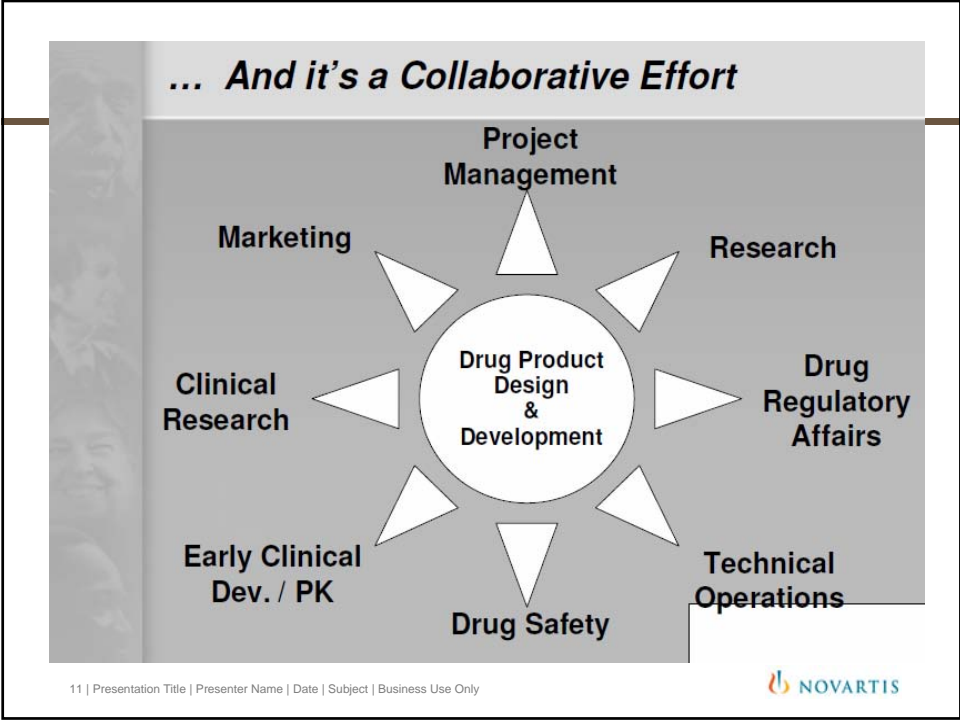

**Translational Medicine**

..... drives innovative and cutting edge Science from Discovery to the Market through the **selection, profiling and effective development** of successful Novartis medicines **to enhance the quality of people's lives**

12 | Presentation Title | Presenter Name | Date | Subject | Business Use Only

## Novartis Translational Medicine Global locations

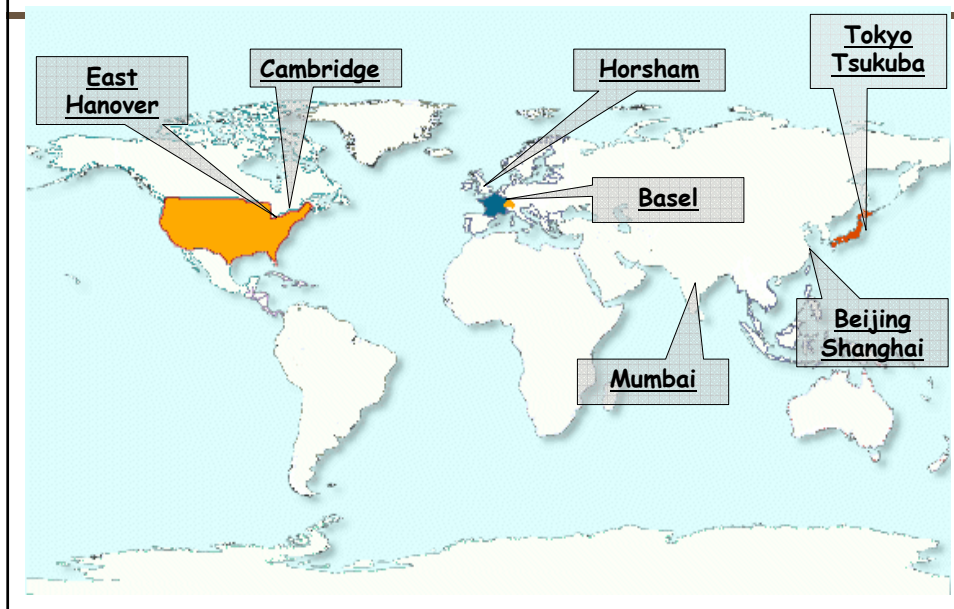

## Types of studies – Classic Clinical Pharmacology

About 60% of the studies run by TM are simple studies with either a PK or safety focus

- FIM (single dose)
- QTc
- Drug / drug interaction
- Bio - equivalent
- Bio - availability (absolute or comparative)
- Food effect
- ADME
- Special populations
  - Renal/ Hepatic/ Japanese

## Types of studies – Complex scientific studies

About 40% of the studies in TM are complex studies with Pharmacodynamic or safety focus

- FIM (Multiple dose)
- POC
- Mechanistic
- Methodology
- PK/PD
- Adaptive

## Overview of TM Study Types

### Exploratory Phase

- **1<sup>st</sup> in man (FIM) study: Single dose safety & tolerability study in healthy volunteers or a single dose study in patients (depending on the indication). may already provide relevant PoC readout.**
- **Multiple dose safety & tolerability study in HVs or patients**
- **\*PoC study**
- **Validation studies (e.g. supported by Clinical Innovation Fund)**

\*In many cases SD and MD safety & tolerability studies results are needed for preparation of PoC study

### Confirmatory Phase

- **Human ADME study**
- **Multiple pharmacokinetic studies, e.g. relative / absolute bioavailability, dose linearity, investigation on food, age and gender, special populations (hepatic and renal impairment), drug-drug interaction studies**
- **Imaging / biomarker studies, “mechanistic” studies**
- **ECG studies (preclinical signals)**
- **Phototoxicity study (preclinical signals)**
- **Abuse liability study (study in drug experienced subjects)**

## Single Ascending Dose Study: Classical Design

Randomized, double-blind, placebo-controlled, time lagged, parallel-group, ascending single dose study in HVs to explore safety, tolerability, pharmacokinetics & pharmacodynamics

	week 1	week 2	week 3	week 4	week 5	week 6	week 7	week 8
Cohort 1	0.3 mg <sup>1)</sup> (seq. dosing)							
Cohort 2			1 mg					
Cohort 3				3 mg				
Cohort 4					10 mg			10 mg fed
Cohort 5						30 mg		
Cohort 6							100 mg	

1) start dosing in sequence e.g. 48 hours apart

17 | Presentation Title | Presenter Name | Date | Subject | Business Use Only



## Single Ascending Dose Study : Interleaved Design

Weeks		Week 1	Week 2	Week 3	Week 4	Week 5	Week 6	Week 7	Week 8	Week 9
Cohort 1	A	5 mg			50 mg			Plac		
	B	5 mg			Plac			400 mg		
	C	Plac			50 mg			400 mg		
Cohort 2	A		10 mg			100 mg			Plac	
	B		10 mg			Plac			800 mg	
	C		Plac			100 mg			800 mg	
Cohort 3	A			20 mg			200 mg			Plac
	B			20 mg			Plac			600 mg
	C			Plac			200mg			600 mg

Randomized, double blind, interleaved, ascending dose study with placebo substitution in 36 healthy volunteers (12 per cohort)

18 | Presentation Title | Presenter Name | Date | Subject | Business Use Only



## Multiple Ascending Dose Study: Classical Design

- Design: Randomized, double-blind, placebo-controlled, parallel group, time-lagged, ascending multiple oral dose study
- Objectives: Safety, tolerability, PK and/or PD of ascending multiple oral doses in healthy volunteers
- Sample size: 24 – 36 subjects (depending on number of doses)

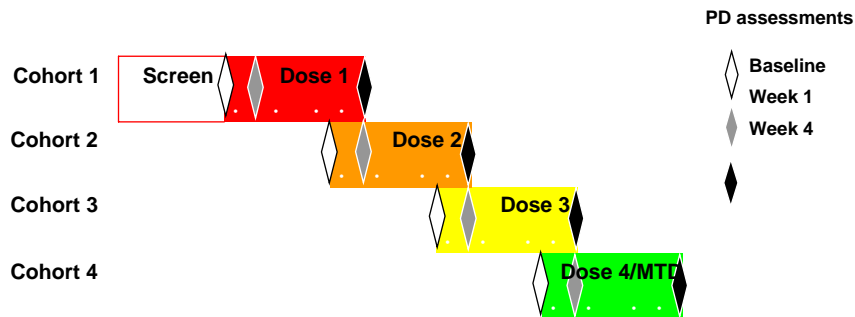

19 | Presentation Title | Presenter Name | Date | Subject | Business Use Only



## Combination of SD/MD: Interwoven Design

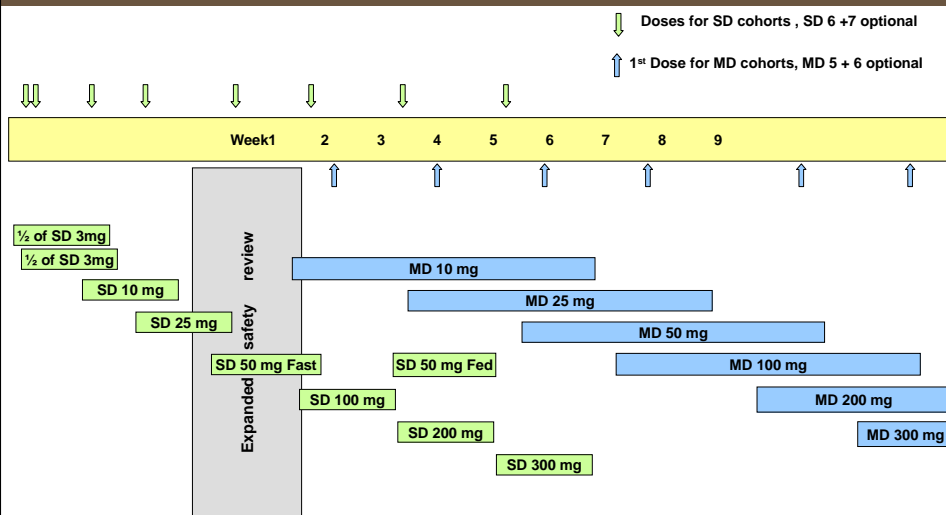

20 | Presentation Title | Presenter Name | Date | Subject | Business Use Only





### PK: 4 period cross - over

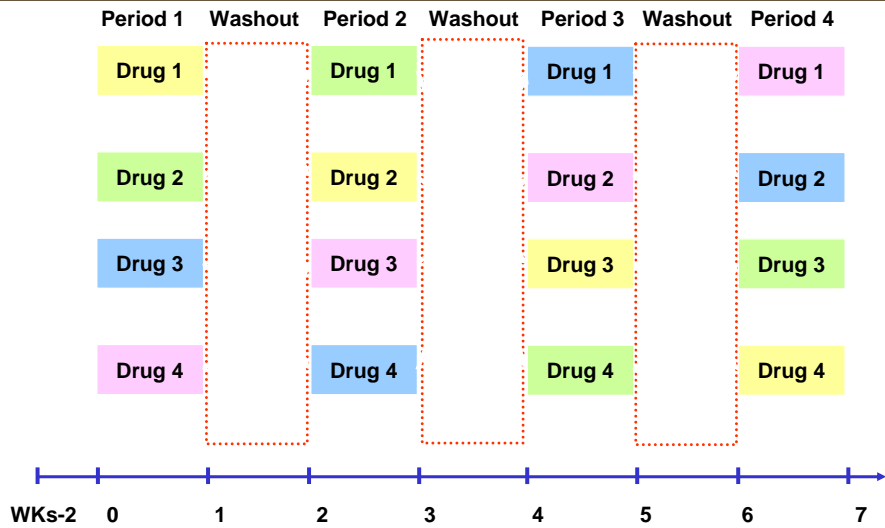

21 | Presentation Title | Presenter Name | Date | Subject | Business Use Only



### PK : 2 period cross - over

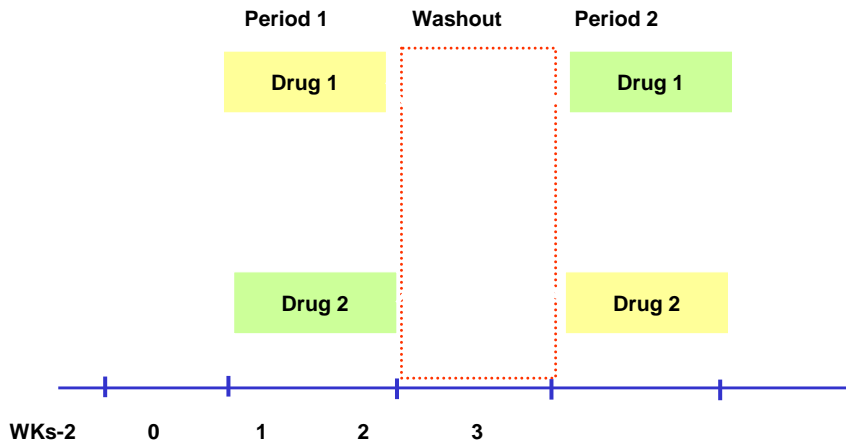

22 | Presentation Title | Presenter Name | Date | Subject | Business Use Only



## Phase I Study Sites

### Healthy Volunteers / Specialized Hospital Clinics (Patients)



23 | Presentation Title | Presenter Name | Date | Subject | Business Use Only



## Concluding Remarks

- The journey of a new molecular entity (NME) from a chemist's/biologist's bench to a drug product in a patient's bedside is a difficult, costly and high risk process.
- There is a continued pressure to shorten the journey (reduce development time) and save costs.
- Most pharmaceutical companies are developing innovative technologies and processes.
- For example, Novartis developed Gleevec® from Phase I clinical to regulatory submission in just 2.7 years, all at risk; the industry standard is 5.9 years!

24 | Presentation Title | Presenter Name | Date | Subject | Business Use Only



## Pressure will continue to grow

1. Patients' and doctors' expectations



2. Payers' willingness to reimburse



3. Liability



4. Sustainability of the pharmaceuticals development's increasing cost of research and development for new medicine is not sustainable".

*Thank You !*

L1

 Health Canada Santé Canada

**Therapeutic Products Directorate** **Direction des produits thérapeutiques**

Health Products and Food Branch Direction générale des produits de santé et des aliments



**Session 6 –Clinical Trial Assessment  
Phase I Clinical Trial**

**Presentation to APEC Preliminary Workshop  
on Review of Drug Development  
in Clinical Trials**

**Celia Lourenco, PhD,  
Manager, Clinical Group I  
Office of Clinical Trials  
Therapeutic Products Directorate**



 Therapeutic Products Directorate Direction des produits thérapeutiques

*Disclaimer: the information within this presentation is based on the presenter's expertise and experience, and represents the views of the presenter for the purposes of a training workshop*

**Slide 1**

---

**L1**

Lourenco, 28/01/2551

## Overview

- Characteristics of Phase I trials
- Core preclinical requirements
- Considerations for biologics
- Considerations for first-in-human
- Preclinical testing of cytotoxic/cytostatic drugs
- Phase I in Oncology, HIV/AIDS, Allergic Rhinitis/Asthma/COPD
- Approaches in protocol and informed consent review
- Common deficiencies
- Exercises

## Characteristics of Phase I Trials (1)

- Subject population: healthy volunteers but for higher risk / potentially toxic drug products such as in oncology or most biologics, patients are recruited
- Sample size typically around 20
- Single-dose escalation or repeat-dose range or escalation
- Randomized double-blind parallel group or cross-over
- Single arm, proof-of-concept
- Thorough QT/QTc studies

## Characteristics of Phase I Trials (2)

- Endpoints:
  - Safety, including effects on QT/QTc interval
  - MTD and recommended Phase II dose (RP2D)
  - PK/PD ( $AUC_t$ ,  $C_{max}$ ,  $T_{max}$ , vs PD markers)
  - Bioavailability
  - Metabolism and elimination (elimination half-life)
  - Drug and food interactions
  - Formulation testing / bioequivalence

## Goals of Preclinical Safety Evaluation

- The primary goals of preclinical safety evaluation are (ICH S6):
  - 1) to identify an initial safe dose and subsequent dose escalation schemes in humans
  - 2) to identify potential target organs for toxicity and for the study of whether such toxicity is reversible
  - 3) to identify safety parameters for clinical monitoring

## Core Toxicity Evaluation (1)

- For single-dose phase I and repeat-dose phase I studies of up to 14 days duration:
  - ADME/toxicokinetics in rodent and non-rodent animal species
  - Safety pharmacology (cardiovascular, CNS, respiratory – ICH S7A)
  - Non-clinical evaluation of the potential for QT-prolongation (ICH S7B)
  - Single-dose in 2 mammalian species (ICH M3)
  - 14-day repeat-dose in rodent and non-rodent animal species (ICH M3)

## Core Toxicity Evaluation (2)

- Genotoxicity studies (ICH S2B):
  - A test for gene mutation in bacteria
  - An *in vitro* test with cytogenetic evaluation of chromosomal damage with mammalian cells **or** an *in vitro* mouse lymphoma tk assay
  - An *in vivo* test for chromosomal damage using rodent hematopoietic cells



## Core Toxicity Evaluation (3)

### – Reproductive toxicity studies (ICH M3):

- Male and female reproductive organs should always be evaluated in the repeated-dose toxicity studies
- Japan - assessment of female fertility and embryo-fetal development should be completed prior to the inclusion of women of childbearing potential using birth control in any type of clinical trial
- EU - assessment of embryo-fetal development should be completed prior to Phase I trials in women of childbearing potential and female fertility studies prior to Phase III trials

## Core Toxicity Evaluation (4)

### – Reproductive toxicity studies (ICH M3, continued):

- US & Canada - women of childbearing potential may be included in early, carefully monitored studies without reproduction toxicity studies provided appropriate precautions are taken to minimise risk (male and female reproductive organs are evaluated in repeated-dose toxicity studies)
- Pregnant women - Prior to the inclusion of pregnant women in clinical trials, all the reproduction toxicity studies and the standard battery of genotoxicity tests should be conducted, and safety data from previous human exposure are generally needed

## Core Toxicity Evaluation (5)

- Local tolerance: assessment of local tolerance may be part of other toxicity studies

## Considerations for Biologics (1)

### ICH S6: Preclinical Safety Evaluation of Biotechnology-Derived Pharmaceuticals

- Specifications of test material:
  - It is preferable to rely on purification processes to remove impurities and contaminants rather than to establish a preclinical testing program for their qualification
  - The product should be sufficiently characterised to allow an appropriate design of preclinical safety studies
  - In general, the product that is used in the definitive pharmacology and toxicology studies should be comparable to the product proposed for the initial clinical studies

## Considerations for Biologics (2)

- **Preclinical safety testing should consider:**
  - selection of the relevant animal species
  - age
  - physiological state
  - the manner of delivery, including dose, route of administration, and treatment regimen
  - stability of the test material under the conditions of use

## Considerations for Biologics (3)

- Safety evaluation programs should normally include two relevant species
- A relevant species is one in which the test material is pharmacologically active due to the expression of the receptor or an epitope (in the case of monoclonal antibodies)
- Sample size adequate to assess potential toxicity; frequent and prolonged monitoring (e.g., when using non-human primates)

## Considerations for Biologics (4)

- Measurement of antibodies should be performed when conducting repeated dose toxicity studies
- The effects of antibody formation on PK/PD parameters, incidence and/or severity of adverse effects, complement activation, or the emergence of new toxic effects should be considered
- Attention should also be paid to the evaluation of possible pathological changes related to immune complex formation and deposition

## Considerations for Biologics (5)

- Standard battery of genotoxicity studies generally not applicable
- Standard carcinogenicity bioassays are generally inappropriate for biotechnology-derived pharmaceuticals
  - To explore carcinogenic potential, may use malignant and normal cell lines
  - When *in vitro* data give cause for concern about carcinogenic potential, further studies in relevant animal models may be needed

## Preclinical Testing for Cytotoxic/Cytostatic Drugs (1)

EMA: Note for guidance on the pre-clinical evaluation of anticancer medicinal products

### Drug Activity:

- In vitro activity profile on panel of cell lines
- In vivo animal tumour model

### Evaluate Toxicity:

- To establish the MTD to be used to define the starting dose in Phase I
- To identify effects on vital functions and target organ toxicity in relation to drug exposure and “treatment cycles” to support dose escalation in Phase I studies and duration of therapy

## Preclinical Testing for Cytotoxic/Cytostatic Drugs (2)

- Safety pharmacology for compounds with a novel mechanism of action
- Single-dose studies in mice and rats to determine MTD
- Repeated-dose toxicity study of limited duration (2 to 4 weeks or 1 to 2 cycles) in two rodent species to assess target organ toxicity and reversibility of effects
- Rodent and non-rodent for drugs with novel mechanism of action
- Genotoxicity/carcinogenicity not required prior to Phase I and II
- Reproduction toxicity studies not required
- Local tolerance

## Considerations for FIH (1)

- **EMA guidance:** Guideline on strategies to identify and mitigate risks for first-in-human clinical trials with investigational medicinal products
- Factors of risk may include the drug's mode of action, the nature of the target, and/or the relevance of animal models:
  - Mode of action on **multiple signalling pathways** or targets that are expressed in many tissues
  - **Amplification** of an effect that might not be sufficiently controlled by a physiologic feedback mechanism (e.g., immune system; blood coagulation system)

## Considerations for FIH (2)

### Factors of risk (continued)

- Insufficient knowledge on the structure, tissue distribution (including expression in immune cells), cell specificity, disease specificity, regulation, level of expression, and biological function of the **human target** including “down-stream” effects, and how it might vary between individuals in different populations of healthy subjects and patients
- Insufficient information on **polymorphisms** of the target in relevant animal species and humans, and the impact of polymorphisms on the pharmacological effects of the medicinal product

## Considerations for FIH (3)

### Factors of risk (continued)

- **Questionable relevance** of animal species/models or surrogates for thorough investigation of the pharmacological and toxicological effects of the medicinal product
- **Quality aspects:** determination of strength and potency; qualification of material used; reliability of very small doses
- **If factors of risk identified**, should estimate the starting dose in humans using the Minimal Anticipated Biological Effect Level (MABEL) in addition to the NOAEL

## Considerations for FIH (4)

- Study protocol should be designed to mitigate risk factors, with consideration given to the following aspects:
  - Study population
  - Trial site
  - First dose
  - Route and rate of administration
  - Number of subjects per dose increment (cohort)
  - Sequence and interval between dosing of subjects within the same cohort
  - Dose escalation increments
  - Transition to next dose cohort
  - Stopping rules
  - Allocation of responsibilities for decisions with respect to subject dosing and dose escalation

## Starting dose (1)

- **FDA Guidance for Industry:** Estimating the maximum safe starting dose in initial clinical trials for therapeutics in adult healthy volunteers (mainly for systemic therapies)
- **Scaling factors used to convert NOAEL in each species tested to a human equivalent dose**
- **Safety margin of at least 10 should be considered (HED/10)**
- **Starting dose in FIH using patients is dependent on many factors: patient population, disease, animal PK or PK/PD, animal dose-toxicity data, or other non-clinical data**

## Starting dose (2)

### **Other common methods to determine the starting dose:**

- The similar drug approach that may be used when clinical data are available for another compound of the same chemical class as the investigational drug
- The pharmacokinetically guided approach that uses systemic exposure rather than dose for the extrapolation from animal to man
- The comparative approach that consists of utilizing two or more methods to estimate a starting dose and then critically comparing the results to arrive at the optimal starting dose

*(Eur.J.Clin.Pharmacol. V.57:835-845, 2002)*



## Phase I in Oncology (1)

### Objectives of Phase 1 oncology trials

- Evaluate safety and tolerance
- Determine dose-limiting toxicity
- Define maximum tolerated dose
- Define optimal biologically active dose
- Determine dose and schedule for initial Phase II efficacy trials
- Evaluate pharmacokinetics (ADME)
- Evaluate effects on molecular target or pathway
- Observe for preliminary evidence of antitumour activity

*(Br J Clin Pharmacol. 2006 July; 62(1): 15–26)*

## Phase I in Oncology

- Goal is to escalate to the MTD rapidly, but safely, to minimize the likelihood of treating patients at doses that are too low to yield benefit or too high that they do harm

## Phase I in Oncology (2)

- Approaches to determine starting dose:
  - 1/3 of the toxic dose low (TDL) in a large animal species (TDL = the lowest dose that produces drug-induced pathological alterations in hematological, chemical, clinical, or morphological parameters and which, when doubled, produces no lethality)
  - 1/10 of lethal dose in mice (expressed in mg/m<sup>2</sup>) if nontoxic in large species

## Dose-Escalation Methods (1)

- Modified Fibonacci sequence (100%, 67%, 50%, 40%, and 33%), where 3 patients treated per cohort
- Target dose-limiting toxicity rate (e.g., 33%, 50%) chosen based on whether or not the drug has potential for unpredictable, irreversible, or life-threatening toxicity
- DLT = consists of serious or life-threatening side effects, but reversible
- Escalation methods are “adaptive”

## Dose-Escalation Methods (2)

- **For toxicity rate of 33%:**
  - If 0/3 patients has DLT, then escalate
  - If 2/3 or 3/3 patients have DLT, then escalation stops and the current dose is the MTD
  - If 1/3 patients has DLT, then 3 additional patients are treated; the dose is escalated only if none of the 3 additional patients has DLT

MTD = dose at which  $\geq 2$  patients experience DLT

RP2D = next lower dose at which no more than 1/6 patients has DLT

## Dose-Escalation Methods (3)

- **For toxicity rate of 50%:**
  - If 0/3 patients has DLT, then escalate
  - If 3/3 patients have DLT, then escalation stops, and the current dose is the MTD
  - If 1/3 or 2/3 patients has DLT, then 3 additional patients are treated. The dose is escalated only if  $\leq 2/6$  patients have dose-limiting toxicity

MTD= dose at which  $\geq 3$  patients experience DLT

RP2D= next lower dose at which  $\leq 2/6$  patients have DLT

## Dose-Escalation Methods (4)

- Bayesian methods where set of prior information and data on each subject is taken into consideration in deciding the dose for the next subject
- For newer targeted therapies, goal may be to determine the biological effect level rather than the MTD

## Dose-Escalation Methods (5)

- Dose-limiting toxicities should be defined
  - Specific toxicities may be defined based on the known toxic effects of the drug (e.g., haematological toxicity) and/or
  - Defined as any toxicity of a pre-defined threshold grade
  - Grading of toxicities must be based on an established toxicity scale such as the NCI CTCAE v.3

## Phase I Studies in HIV/AIDS

- Single-dose and repeated-dose, double-blind, placebo-controlled studies in healthy volunteers, to investigate:
  - Safety and PK
  - PK profile is very important, including terminal half-life and  $C_{min}$  to determine dosing
  - Food-effect and drug-drug interactions
  - Thorough QT/QTc
- Phase I studies in patients where drug is known to be too toxic for healthy volunteers or if the drug is considered high risk (e.g., biologics, immune system as the target)

## Phase I Studies in Allergic Rhinitis, Asthma or COPD

- Single and repeated-dose in healthy volunteers to examine safety, PK, and potential efficacy by examining PD endpoints in controlled-environment studies of ozone challenge model for COPD
- Single and repeated-dose in atopic patients to examine safety, PK, and potential efficacy by examining PD endpoints in controlled-environment studies of allergen inhalation challenge (allergic rhinitis, asthma, COPD)

## Approach in Review

- Benefit / risk judgement call:
  - Lower risk products → healthy volunteers
  - Higher risk products → patients
  - Potential toxicity with drug target (e.g., immune system, coagulation pathway)
  - Route of administration
  - Adequacy of pre-clinical program
  - Extent of toxicological findings
- Regardless of study population, always link the nonclinical toxicological findings to the clinical safety assessments

## Protocol Assessment (1)

- Background and Rationale
- Trial Objectives
- Study Design and Duration
- Study Site(s)
- Sample Size
- Subject Population

## Protocol Assessment (2)

- Eligibility Criteria
- Drug Formulation and Dosages
- Pre-study Screening and Baseline Evaluation
- Treatment / Assessment Visits
- Concomitant Medication

## Protocol Assessment (3)

- Rescue Medication & Risk Management
- Premature Withdrawal / Discontinuation Criteria
- Efficacy Variables and Analysis
- Safety Variables and Analysis

## Informed Consent Assessment (1)

- Ensure that the informed consent form explains:
  - The objectives of the trial and that it involves research
  - That there are no benefits to healthy volunteers and/or no anticipated benefits to patients
  - That the drug has never been administered to humans before (if applicable) or describes all previous studies in humans
  - The preclinical toxicity findings and potential adverse events for the drug, including any information on the drug's teratogenicity and the importance of contraceptive precautions

## Informed Consent Assessment (2)

- Ensure that the informed consent form explains:
  - All the tests and procedures related to the trial, including duration of visits, overnight stays
  - The total amount of blood taken and provides a comparison measure such as a standard blood donation
  - Clearly informs subjects of their rights, that their enrolment in the trial is voluntary and they are free to withdraw from the study at any time
  - That their medical records may be accessed by the regulator mandated to oversee clinical trials



## Common Deficiencies of Phase I Proposals

- Insufficient pre-clinical data
- No animal model or, for immunological reasons, data in animals is unreliable
- Healthy volunteers vs. patients
- Due to lack of resources, sponsors just want to try a study in humans “to get some human data”
- Previous human data is from completely different patient population and sponsor lacks pre-clinical animal model

## References

EMEA FIH	<a href="http://www.emea.europa.eu/pdfs/human/swp/2836707enfin.pdf">http://www.emea.europa.eu/pdfs/human/swp/2836707enfin.pdf</a>
EMEA Oncology	<a href="http://www.emea.europa.eu/pdfs/human/swp/099796en.pdf">http://www.emea.europa.eu/pdfs/human/swp/099796en.pdf</a>
FDA FIH healthy volunteers	<a href="http://www.fda.gov/cder/guidance/5541fnl.pdf">http://www.fda.gov/cder/guidance/5541fnl.pdf</a>
Clinical PSEAT	<a href="http://www.hc-sc.gc.ca/dhp-mps/alt_formats/hpfb-dgpsa/pdf/prodpharma/pseat_cta_meiep_dec_e.pdf">http://www.hc-sc.gc.ca/dhp-mps/alt_formats/hpfb-dgpsa/pdf/prodpharma/pseat_cta_meiep_dec_e.pdf</a>

L1

 Health Canada Santé Canada

**Therapeutic Products Directorate** **Direction des produits thérapeutiques**

Health Products and Food Branch Direction générale des produits de santé et des aliments



**Session 7 – Clinical Trial Assessment  
Bioequivalence Studies**

**Presentation to APEC Preliminary Workshop  
on Review of Drug Development  
in Clinical Trials**

**Celia Lourenco, PhD,  
Manager, Clinical Group I  
Office of Clinical Trials  
Therapeutic Products Directorate**



 Therapeutic Products Directorate Direction des produits thérapeutiques

*Disclaimer: the information within this presentation is based on the presenter's expertise and experience, and represents the views of the presenter for the purposes of a training workshop*

## Slide 1

---

L1

Lourenco, 28/01/2551

## Overview

- Regulations & Guidance
- Objective & characteristics of bioequivalence studies
- Data requirements
- Study designs
- Essential components in the review

## Regulations & Guidance

- Comparative bioavailability studies fall under Division 5 and a CTA is required (regulations apply as for other clinical trials)
- 7 day administrative review target; 30 day default if target is not met
- Non-Canadian reference products used to support an Abbreviated New Drug Submission (ANDS) must meet the criteria defined in the HPFB guidance *Canadian Reference Product* (December 4, 1995)
- Guidance for clinical trial sponsors on how to file an application for a comparative bioavailability study is available

## Guidance for Registration (1)

- Conduct and analysis of bioavailability and bioequivalence studies
  - Part A: Oral Dosage Formulations Used for Systemic Effects
  - Part B: Oral Modified Release Formulations
- Report C: Report on Bioavailability of Oral Dosage Formulations, not in Modified Release Form, of Drugs Used for Systemic Effects, Having Complicated or Variable Pharmacokinetics
- Notice to Industry - Bioequivalence Requirements for Long Half-life Drugs

## Guidance for Registration (2)

- Bioequivalence Requirements: Critical Dose Drugs
- Notice to Industry - Bioequivalence Requirements for Drugs for Which an Early Time of Onset or Rapid Rate of Absorption Is Important (rapid onset drugs)
- Guidance for Industry: Bioequivalence Requirements: Comparative Bioavailability Studies Conducted in the Fed State
- Draft Guidance for Industry: Use of Metabolite Data in Comparative Bioavailability Studies
- Notice to Industry - Bioequivalence Requirements for Combination Drug Products

## Data Requirements

- Format is the same as for a CTA
  - HC form 3011 with signed attestation
  - Clinical package
  - CMC package
- QOS-BE template to be filled-out by sponsor and submitted
- Clinical package to include the protocol, informed consent form and Canadian Product Monograph (or similar document for a comparator product not marketed in Canada)

## Objective & Characteristics

### Objective of Comparative Bioavailability Studies:

- To test the formulation of a subsequent-entry pharmaceutical product as compared to a reference

### Characteristics

- Healthy adult volunteers
- Canadian reference product or product that is marketed in US, EU, Australia, or Switzerland
- Single or total daily dose does not exceed that specified in the labelling of the reference drug product
- The study does not include the simultaneous administration of a radioactive labelled and unlabelled drug product

## Study Designs

- Single dose with a two period cross-over design
- Conducted in fasted and fed state (if indicated to be taken with food)
- Three and four-period cross-over for modified-release formulations
- Some studies involve parallel group designs
- Steady-state studies for formulations likely to accumulate (e.g., delayed release drug products)

## Endpoints

- Pharmacokinetic parameters (e.g.,  $AUC_t$ ,  $C_{max}$ ,  $T_{max}$ , elimination  $t_{1/2}$ ,  $AUC_{tau}$ ,  $C_{min}$ )
- Safety of the new formulation as compared to the reference

## Quality Review

- Information on Canadian Reference Product or Non-Canadian Reference Product
- Drug substance:
  - Attestations (GMP, ICH organic solvents, TSE/BSE)
  - Batch analyses
- Drug product:
  - Composition of dosage form
  - Attestation (non-medicinal ingredients consistent with reference product, prohibited excipients, GMP)
  - Batch analyses
  - Excipients of human or animal origin (information may be submitted later, but 2 days prior to starting the study)

## Clinical Review (1)

- Use a Reviewer's check-list
- Dose as labelled
- Choosing the dose for drugs that need to be titrated ("critical dose" drugs)
- Dose tapering at end of dosing (abrupt discontinuation can lead to withdrawal symptoms)
- Wash-out period should consist of at least 10 terminal elimination half-lives; should not exceed 3 to 4 weeks



## Clinical Review (2)

- Sample size usually >12 and depends on the estimated intra-subject variability
- Eligibility criteria
  - should take into consideration the contraindications, warnings and precautions for the drug
  - TB screening for immunosuppressants or drugs with immunosuppressant properties (medical history and TST)
- Pregnancy testing if females of child-bearing potential included; acceptable contraceptive methods defined

## Clinical Review (3)

- Total blood volume collected should not exceed 500 mL within a 4 week period (minimum time between donations according to the Canadian Blood Services and International Red Cross is 56 days)
- Intravenous catheter for multiple blood draws in early time points
- Risks related to the drug are listed in the informed consent form and acceptable contraceptive methods defined

## Summary

- Some studies are not for Canadian registration
  - allow use of non-Canadian reference product from another ICH region, Australia, or Switzerland
- Health Canada has several guidance documents on the requirements for registration
- Review of comparative bioavailability studies focuses on safety

## References

Guidance for Industry on Clinical Trial Applications for Comparative Bioavailability Studies for Pharmaceuticals	<a href="http://www.hc-sc.gc.ca/dhp-mps/prodpharma/applic-demande/guide-ld/bio/ctabio_decbio_e.html">http://www.hc-sc.gc.ca/dhp-mps/prodpharma/applic-demande/guide-ld/bio/ctabio_decbio_e.html</a>
Quality Overall Summary Template for Comparative Bioavailability Studies	<a href="http://www.hc-sc.gc.ca/dhp-mps/alt_formats/hpfb-dgpsa/pdf/prodpharma/qoscectaba_sgqecdeceb_e.pdf">http://www.hc-sc.gc.ca/dhp-mps/alt_formats/hpfb-dgpsa/pdf/prodpharma/qoscectaba_sgqecdeceb_e.pdf</a>
Quality Guidance for Clinical Trial Sponsors – Clinical Trial Applications	<a href="http://www.hc-sc.gc.ca/dhp-mps/prodpharma/applic-demande/guide-ld/clini/qual_cta_dec_e.html">http://www.hc-sc.gc.ca/dhp-mps/prodpharma/applic-demande/guide-ld/clini/qual_cta_dec_e.html</a>
Notice for TB screening	<a href="http://www.hc-sc.gc.ca/dhp-mps/prodpharma/applic-demande/guide-ld/clini/tuberc_notice_avis_e.html">http://www.hc-sc.gc.ca/dhp-mps/prodpharma/applic-demande/guide-ld/clini/tuberc_notice_avis_e.html</a>



## 7. Clinical Trial Assessment Bioequivalent Studies (Generic)

Junko Sato, PhD  
Office of New Drug I, PMDA



APEC Preliminary Workshop on Review of Drug Development in Clinical Trials  
2007.3.17 – 21, Bangkok, Thailand



## Disclaimer

- *The information within this presentation is based on the presenter's expertise and experience, and represents the views of the presenter for the purposes of a training workshop*



APEC Preliminary Workshop on Review of Drug Development in Clinical Trials  
2007.3.17 – 21, Bangkok, Thailand



## Overview

- Regulations & Guidance
- Objective & characteristics of bioequivalence studies
- Data requirements
- Study designs
- Essential components in the review



APEC Preliminary Workshop on Review of Drug Development in Clinical Trials  
2007.3.17 – 21, Bangkok, Thailand



## Guideline for Bioequivalence Studies of...

- Generic Products
- Topical drug for skin as new formulation
- New content in oral solid forms
- Change of ingredients in oral solid forms
- Generic of topical drug for skin
- Change of manufacturing in controlled release dosage forms
- Change of controlled release dosage forms



APEC Preliminary Workshop on Review of Drug Development in Clinical Trials  
2007.3.17 – 21, Bangkok, Thailand

## Purpose of BE study

- Assure therapeutic equivalence of generic products to innovator products
  - Bioavailability should be compared for innovator and generic products.
  - If this is not feasible, pharmacological effects supporting efficacy or therapeutic effectiveness in major indications should be compared.
  - For oral drug products, dissolution tests should be performed, since they provide important information concerning bioequivalence.

APEC Preliminary Workshop on Review of Drug Development in Clinical Trials  
2007.3.17 – 21, Bangkok, Thailand



## Study methods

- Bioequivalent studies
- **Pharmacodynamic studies**
- **Clinical studies**

APEC Preliminary Workshop on Review of Drug Development in Clinical Trials  
2007.3.17 – 21, Bangkok, Thailand



## Pharmacodynamic studies

- For drugs do not produce measurable concentrations of the parent drug
- For drugs active metabolite in blood or urine and those whose bioavailability does not reflect therapeutic effectiveness
- The Acceptance criteria of equivalence in this study should be established by considering the pharmacological activity of each drug.



APEC Preliminary Workshop on Review of Drug Development in Clinical Trials  
2007.3.17 – 21, Bangkok, Thailand

## Clinical studies

- Performed to establish the equivalence of an index
- If bioequivalence studies and pharmacodynamic studies inappropriate, this study is applied.
- The Acceptance criteria of equivalence in this study should pharmacological characteristics and activity of each drug.



APEC Preliminary Workshop on Review of Drug Development in Clinical Trials  
2007.3.17 – 21, Bangkok, Thailand

## BE Study Design

- Appropriate study protocol including the required number of subjects and sampling intervals should be determined according to preliminary studies and previously reported data.
- **Design**
  - Randomized crossover studies
    - more than 5 times the elimination half life of the parent drug or active metabolites.
  - Parallel designs can be employed for drugs with extremely long half-lives.
- **Dose:** Single dose by one dose unit or a clinical usual dose

APEC Preliminary Workshop on Review of Drug Development in Clinical Trials  
2007.3.17 – 21, Bangkok, Thailand



## Sampling

- Sampling points should be at least 7, including zero time, 1 point before  $C_{max}$ , 2 points around  $C_{max}$  and 3 points during the elimination phase. Sampling should be continued until  $AUC_t$  is over 80% of  $AUC_{\infty}$  (normally more than 3 times the elimination half life after  $t_{max}$ ).

APEC Preliminary Workshop on Review of Drug Development in Clinical Trials  
2007.3.17 – 21, Bangkok, Thailand





## Bioequivalence range

- AUC and Cmax are logarithmically distributed
  - 0.8–1.25 as the ratios of average AUC and Cmax of test product to reference product
- AUC and Cmax are normally distributed
  - -0.2 – +0.2 as the ratio of the relative difference in the mean AUC and Cmax between reference and test products to those of the reference product



APEC Preliminary Workshop on Review of Drug Development in Clinical Trials  
2007.3.17 – 21, Bangkok, Thailand



## Reference

- **Guideline for Bioequivalence Studies of Generic Products**
  - [http://www.nihs.go.jp/drug/be-guide\(e\)/Generic/be97E.pdf](http://www.nihs.go.jp/drug/be-guide(e)/Generic/be97E.pdf)



APEC Preliminary Workshop on Review of Drug Development in Clinical Trials  
2007.3.17 – 21, Bangkok, Thailand



## 8. Clinical Trial Assessment Phase II

Junko Sato, PhD  
Office of New Drug I, PMDA

APEC Preliminary Workshop on Review of Drug Development in Clinical Trials  
2007.3.17 – 21, Bangkok, Thailand



## Disclaimer

***❁ The information within this presentation is based on the presenter's expertise and experience, and represents the views of the presenter for the purposes of a training workshop***

APEC Preliminary Workshop on Review of Drug Development in Clinical Trials  
2007.3.17 – 21, Bangkok, Thailand



## Overview

- Purpose
- Type of Study
- Type of Control
- Endpoint
- Selection of population
- Risk vs benefit
- Risk mitigation
- Risk communication
- Reference
- Exercises



APEC Preliminary Workshop on Review of Drug Development in Clinical Trials  
2007.3.17 – 21, Bangkok, Thailand

## Purpose of phase II

- Link animal and human findings
- Estimate efficacy and Safety
- Select dose and dose interval
- To success phase III studies, furthermore to success development of the drug !



APEC Preliminary Workshop on Review of Drug Development in Clinical Trials  
2007.3.17 – 21, Bangkok, Thailand

## Type of Study

- **Comparative vs non-comparative**
- **Randomized**
- **Blind vs unblinded**
- **Proof of concept**



APEC Preliminary Workshop on Review of Drug Development in Clinical Trials  
2007.3.17 – 21, Bangkok, Thailand

## Comparative or non-comparative?

- **If comparator is not included in the studies...**
  - **How to measure the magnitude of efficacy and safety?**
  - **Are results of past studies useful for evaluation of developing drug?**



APEC Preliminary Workshop on Review of Drug Development in Clinical Trials  
2007.3.17 – 21, Bangkok, Thailand

## Randomized Control Study

- ❁ **Why an intervention group and a control group are needed ?**
  - ❁ **To remove investigator bias in allocation of participants**
  - ❁ **To guarantees that statistical tests will have valid significance levels**



APEC Preliminary Workshop on Review of Drug Development in Clinical Trials  
2007.3.17 – 21, Bangkok, Thailand

## Blind vs unblinded

- ❁ **To avoid potential problems of bias during data collection and assessment**
- ❁ **Should have a double-blind design. If impossible, a single-blind approach and other measures to reduce potential bias are favored**



APEC Preliminary Workshop on Review of Drug Development in Clinical Trials  
2007.3.17 – 21, Bangkok, Thailand

## Proof of concept

- ❁ **Important studies in drug development**
- ❁ **Provide evidence that the hypothesized mechanism is affected by the drug**
- ❁ **Provide evidence that the effect on the mechanism leads to a desired short-term clinical outcome**



APEC Preliminary Workshop on Review of Drug Development in Clinical Trials  
2007.3.17 – 21, Bangkok, Thailand

## Type of Control

- ❁ **Placebo control**
- ❁ **Specified active agent**
- ❁ **Optimal Basic Therapy**
  - ❁ **Any medicines**
  - ❁ **Any therapy (Surgical treatment etc.)**



APEC Preliminary Workshop on Review of Drug Development in Clinical Trials  
2007.3.17 – 21, Bangkok, Thailand

## Objectives

- **Efficacy**
- **Safety**
- **Pharmacokinetic in patients**
  - **Condition of disease**
  - **Concomitant drugs**
- **Interaction with food/drugs**



APEC Preliminary Workshop on Review of Drug Development in Clinical Trials  
2007.3.17 – 21, Bangkok, Thailand

## Example

- **Antibiotics**
- **Identified what PK/PD parameter is depend on efficacy**
- **Approved in over 80 countries some years ago**
- **An industry would like to launch it in our country**
- **PK in our healthy volunteer is similar with foreigners**



APEC Preliminary Workshop on Review of Drug Development in Clinical Trials  
2007.3.17 – 21, Bangkok, Thailand

## Selection of population

- ❁ **Group of which benefit is expected**
- ❁ **What population is target of the drug after launched ?**
- ❁ **At beginning of clinical development, inclusion criteria is so restricted.**
  - ❁ **Age (not include elderly, pediatrics, etc)**
  - ❁ **Organ dysfunction (liver, renal, etc.)**
  - ❁ **Severe**



APEC Preliminary Workshop on Review of Drug Development in Clinical Trials  
2007.3.17 – 21, Bangkok, Thailand

## Risk and benefit on participants

- ❁ **Risk**
  - ❁ **Unknown effects**
  - ❁ **First trial for patients**
- ❁ **Benefit**
  - ❁ **More sufficient effect than current drugs ?**



APEC Preliminary Workshop on Review of Drug Development in Clinical Trials  
2007.3.17 – 21, Bangkok, Thailand

## Risk and benefit on development

### ❁ Risk

- ❁ Prolong of development periods
- ❁ Failure of development

### ❁ Benefit

- ❁ Improve the probability of success



APEC Preliminary Workshop on Review of Drug Development in Clinical Trials  
2007.3.17 – 21, Bangkok, Thailand

## Risk mitigation

### ❁ What is identified risks of developing drugs ?

- ❁ Fully grasp character of developing drug
- ❁ Make a system for early detection of risks
- ❁ Timely and appropriate evaluation through trials
- ❁ Back to non-clinical, if necessary



APEC Preliminary Workshop on Review of Drug Development in Clinical Trials  
2007.3.17 – 21, Bangkok, Thailand



## Risk communication

- **Share information on developing drugs**
  - What AEs are detected in development?
  - What is risk factors in each AEs ?
  - What method is available for early detection?



APEC Preliminary Workshop on Review of Drug Development in Clinical Trials  
2007.3.17 – 21, Bangkok, Thailand

## Reference

- **Exposure-Response Relationships — Study Design, Data Analysis, and Regulatory Applications**  
<http://www.fda.gov/cder/guidance/5341fnl.pdf>
- **General Considerations for Pediatric Pharmacokinetic Studies for Drugs and Biological Products**  
<http://www.fda.gov/cder/guidance/1970dft.pdf>
- **In Vivo Drug Metabolism/Drug Interaction Studies — Study Design, Data Analysis, and Recommendations for Dosing and Labeling**  
<http://www.fda.gov/cder/guidance/2635fnl.pdf>



APEC Preliminary Workshop on Review of Drug Development in Clinical Trials  
2007.3.17 – 21, Bangkok, Thailand

## Exercise

- ❁ One of fluoroquinolone injection
- ❁ Efficacy depend on AUC/MIC and Cmax/MIC
- ❁ Identified risks are liver and renal toxicity
- ❁ QT-prolongation, seizure and joint-  
/surrounding tissue problem in juvenile  
animals are known in same class.



APEC Preliminary Workshop on Review of Drug Development in Clinical Trials  
2007.3.17 – 21, Bangkok, Thailand

## Exercise (cont.)

- ❁ How to select dose (amount and interval) ?
- ❁ What population is suitable for early Phase II ?
- ❁ What should we do for risk minimization ?
  - ❁ Inclusion/exclusion criteria ?
  - ❁ What and how should we monitor ?



APEC Preliminary Workshop on Review of Drug Development in Clinical Trials  
2007.3.17 – 21, Bangkok, Thailand



**APEC Preliminary Workshop: Review of Drug Development in Clinical Trials**

**Session 9 A– Clinical Trial Assessment – Phase III**

**Susan D’Amico**  
Vice President and Global Head  
Clinical Quality Assurance

 **NOVARTIS**

© 2008 Novartis

## Disclaimer

- *The information within this presentation is based on the presenter's expertise and experience, and represents the views of the presenter for the purposes of a training workshop*

*Slides Adapted from Presentation by:*

*Richard C. Meibach, Ph.D.  
Scientific Officer, Global Development*

*ECPM Course: “Learning and Confirming Trials”*

*<http://www.ecpm.ch/ecpm/english/ecpmcourse/session3.html>*



## What is a protocol?

“A document that describes the objective(s), design, methodology, statistical considerations, and organization of a trial..”

ICH GCP protocol definition



## Enhancing Consistency: Regulatory Protocols

- ICH E6 Section 6 “Guideline for Good Clinical Practice”
- Intended for regulatory submissions
- Unified standard for EU, Japan and US for acceptance of clinical data
  - Developed with consideration of Australia, Canada, the Nordic countries and the WHO GCP’s



## Protocol Content– ICH E6



- General information
  - Title, Contacts, ID
- Background
  - Name, Synopsis, Product
- Trial Objectives/Purpose
- Trial Design
  - Exposure, Endpoints, Subject incl/excl
- Treatment of Subjects
  - Dosage regimen
- Efficacy Assessment
  - Statistical plan
- Safety Assessment
  - Statistical plan
- Statistics
  - Sample size
- Access to source documents
- QA/QC
- Ethics
- Data Management
- Financing/Insurance
- Supplements



## Traditional Phases of Clinical Trials

- Protocols differed depending on the phase of drug development:
- **Phase I** studies – first test in humans, usually healthy normal volunteers, objectives are tolerability and pharmacokinetics
- **Phase II** first patient studies to look at efficacy and safety
- **Phase III** larger trials to convince regulatory agency of the efficacy and safety of the investigational drug
- **Phase IV**: post marketing trials to support use of the drug. Less rigorous design may not even be controlled



## Issues that Can Occur with Traditional Phased Approach

- ✓ Most compounds were safe enough to get through phase I – no real screening took place
- ✓ Did not have any evidence of efficacy until the end of phase II
- ✓ Many trials had insufficient safety and efficacy at the end of phase II and therefore went into phase III at high risk
- ✓ Many trials failed at the end of phase III costing hundreds of millions of dollars
- ✓ Several drugs made it to market only to have to be dropped for safety problems
  - ✓ Tasmar – Roche drug for PD
  - ✓ Posicor – Roche drug for hypertension
  - ✓ Hismanal – Janssen drug for allergic rhinitis
- ✓ Drugs get approved but we find out we got the dose wrong



## Enhanced Approach in Clinical Development with Protocols of Today

- The phased development approach of drugs is NOT a requirement but is a guidance.
- As long as there is sufficient safety data one can proceed faster and hopefully smarter.
- We are in a transition phase to improved protocol designs
  - Patients can be studied in phase I and some efficacy can be obtained – often called Ib (includes experimental medicine and translational medicine, proof of concept, seamless designs)
  - Phase II can be divided in half – Phase IIa and IIb
  - Phase II can be skipped
  - Phase II can be combined with Phase III (adaptive designs)



## Protocols of the Future

- Wyeth recently announced the best model for the 21<sup>st</sup> century:
- Phases I, 2 and 3 will be replaced with Learn and Confirm studies
- FDA critical path initiative – started in 2004.
- March, 2006 issuance of update
- Part 1- Report. What has been learned since 2004
- Part 2 – List. What opportunities are available.
  - Biomarker Development
  - Streamlining clinical trials
  - Bioinformatics
  - model based drug development
  - data pooling consortium



## Protocol Design

- Due to increasing pressure on our industry, protocols are no longer considered “proprietary and confidential”
- Most regulatory authorities prefer consistency – do not change design unless the MOA dictates a change
- There are many places to go to find protocol designs as more and more clinical trial registries are posted
  - <http://ctr.gsk.co.uk/welcome.asp>
  - <http://www.roche-trials.com/registry.html>
  - <http://www.ifpma.org/> (not yet operational)
  - <http://www.lillytrials.com/>
  - <http://www.wyeth.com/ClinicalTrialListings>
- The FDA has a website for all NDA reviews which usually include details of the protocol <http://www.accessdata.fda.gov/scripts/cder/drugsatfda/>



## Objectives of Study

- Avoid general statements (e.g. to study the safety and efficacy of drug x in the treatment of Y)
- Insure that every procedure can be linked back to an objective (e.g. Do not collect blood samples for population pK unless that is one of the objectives)





## Objectives (con't)

- Avoid having too many objectives in a trial
  - Pharmacokinetics
  - Genetics and genomics testing
  - Quality of life
  - Cost effectiveness
  - Testing new rating scales
  
- Should break down objectives to Primary, Secondary and Exploratory



## Study Design

- Most often studies are blinded
  - Single-Blind
  - Double-blind
  - Open label with blinded rater
  
- If blinded, protocols must state conditions under which blind may be broken



## Study Design (con't)

- In order to prevent selection bias, patients must be randomized to their treatment
- Comparison of two treatments can be done in parallel or crossover
  - Preferred design is parallel –uses more patients
  - If crossover need to insure there is total washout of effect



## Inclusion and Exclusion Criteria

- In general the amount of inc/exc should decrease as you learn more about the drug and the development has proceeded closer to approval.
- If you have too many restrictions, regulatory agencies may put those restrictions in the label
- They may also require you to perform a labeling study prior to approval



## Protocol Requirements

- When scheduling tests, should not pose a burden to a patient (ie keeping them in the doctors office for five hours)
- The number of tests should decrease as the drug moves to the next phase (e.g. the drug has already been submitted to health authorities for approval. The drug has no CV and liver toxicities. You start a 6 month phase IIIb trial and have monthly ECG's and weekly laboratory tests. Why?)



## Choosing a Dose

- How do we choose the initial dose in human?
  - Used to be rather arbitrary
    - Some picked 1/10 the expected efficacious dose
    - Some picked 1/3 the dose of animal tox
    - Some picked 1/10 the mouse LD<sub>10</sub> dose
  - Today we use a formula developed by the FDA
    - Take the highest dose in which there was no AE's in an animal tox study = NOAEL
    - Convert this to the Human Equivalent Dose (HED) using a standard formula based on body surface area
    - Start at 1/10<sup>th</sup> the HED



## Protocol Amendments

- True or False?
  - Any change to a protocol is called an amendment



## Protocol Amendments

- False
  - An amendment is any change to a protocol once it has been submitted to an IRB/Ethics Committee or Health Authority for approval



## Amendments

- Amending a protocol is necessary at times *however*
  - It can delay timelines
  - It increases workload
  - It increases development costs
  - It decreases investigator satisfaction



## Amendments

- When does a protocol get amended?
  - A protocol can be changed at any time
  - When a change is made BEFORE it has been reviewed by a regulatory authority or an IRB/Ethics Committee for approval purposes it is considered a revision and not an amendment
  - Revisions are not tracked – no histories need to be kept



## Amendments

- When an amendment is necessary – there needs to be an audit trail. We need to know what the original version looked like.
- Therefore one can change the body of the protocol as long as there is a log attached of the actual changes.
- Although a protocol can be changed for any reason, it should never be changed to turn a negative trial into a positive trial (eg. increasing sample size is dangerous without appropriate pre defined guidance)



## Summary

- Clinical trial protocols vary depending on the phase of development of the new medicine.
- There are ICH guidelines on the structure of protocols
- One should use protocol designs already approved by regulatory authorities modified for your specific drug
- All of the safety information on the drug must be in a separate Investigator Brochure
- After IRB/EC/HA approval any changes need to be documented and tracked.



## References

- Guide to Clinical Trials, Bert Spilker 1991, Raven Press, New York
- Fundamentals of Clinical Trials, Friedman, Furberg and DeMets 1998, Springer-Verlag, New York
- Understanding, Evaluating and Implementing Clinical Protocols 1999 Barnett International Clinical Training Group, Media PA
- New Drug Development: A regulatory overview, Mark Mathieu, 2005 Parexel, Waltham, MA
- Clinical Trial Registries  
[http://www.campbellalliance.com/articles/Final\\_Clinical\\_Trial\\_Registries\\_3-23-05.pdf#search='clinical%20trial%20registries'](http://www.campbellalliance.com/articles/Final_Clinical_Trial_Registries_3-23-05.pdf#search='clinical%20trial%20registries')



## References (con't)

- Critical path initiative
- [//www.fda.gov/oc/initiatives/criticalpath](http://www.fda.gov/oc/initiatives/criticalpath)
- ICH E6 Good Clinical Practice Guidance, April, 1996



*Thank You  
for your attention !*

Questions ?







**APEC Preliminary Workshop: Review of Drug Development in Clinical Trials**

Session 9 B Clinical Trial Assessment  
Patient Protection – Informed Consent

Susan D'Amico  
Vice President and Global Head  
Clinical Quality Assurance



© 2008 Novartis

## Disclaimer

- *The information within this presentation is based on the presenter's expertise and experience, and represents the views of the presenter for the purposes of a training workshop*

## Good Clinical Practice is ...

**“an international ethical and scientific quality standard for designing, conducting, recording, and reporting trials that involve the participation of human subjects”**

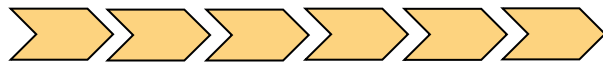

3 | Presentation Title | Presenter Name | Date | Subject | Business Use Only



## Patient Protection: Drug disasters, fraud, and abuse of rights

- Sulphanilamide incident (1937)      ➤ 1938 Drug laws introduced to regulate safe manufacturing of drugs
- Nuremberg War Crimes Trial      ➤ 1949 Nuremberg Code: required voluntary “informed consent”
- Tuskegee study (syphilis) (1932 – 1972)      ➤ 1979 Belmont report: interest of individual is above interest of society
- Thalidomide (birth defects)      ➤ 1962 Kefauver Amendments: prove drugs are both safe and effective

4 | Presentation Title | Presenter Name | Date | Subject | Business Use Only



## World Medical Association (WMA) Declaration of Helsinki

- **Adopted by the 18<sup>th</sup> WMA general assembly, Helsinki - June 1964**
- **Established ethical principles for medical research involving human subjects**
- **Informed consent must be documented**
- **Independent review of protocol by ethics committee (IRB/IEC\*)**

\*IRB - Institutional Review Board / IEC- Independent Ethics Committee  
In this training the term ethics committee may be used to address both

5 | Presentation Title | Presenter Name | Date | Subject | Business Use Only



## Declaration of Helsinki

- **October 2000 - latest revision from 52<sup>nd</sup> WMA General Assembly, Edinburgh**
- **Clarifications 2002 and 2004:**
  - **Placebo controlled trials now appropriate to conduct in some cases (benefit > risk)**
  - **Sponsor should address how subjects will be treated after study termination**
  - **Ability of country to afford medication (i.e. AIDs trials in Africa)**
- **WMA is updating for new release in 2008**

6 | Presentation Title | Presenter Name | Date | Subject | Business Use Only



## US Code of Federal Regulations Title 21 – Food and Drugs

- **Audit of trials registered with FDA during 1970s**
  - **Patient protection in question**
  - **30% of investigators not adhering to protocols**
  - **Data fabrication, fraud identified**
- **FDA issues Federal Regulations**
  - **21 CFR50 – Protection of human subjects**
  - **21 CFR56 – Institutional Review Boards**
  - **21 CFR312 – Investigational New Drug Application**

7 | Presentation Title | Presenter Name | Date | Subject | Business Use Only



## Basic Principles of ICH GCP

1 of 2

- 1. Studies conducted according to Declaration of Helsinki and GCP**
- 2. Anticipated benefits must justify the risk**
- 3. Subjects rights, safety and well being come first**
- 4. Adequate information available to support the proposed study**
- 5. Protocol – scientifically sound, clearly described and detailed**
- 6. Ethical committee approval**
- 7. Qualified physician responsible for medical care and decisions**

8 | Presentation Title | Presenter Name | Date | Subject | Business Use Only



## Basic Principles of ICH GCP

2 of 2

8. All individuals involved – qualified by education, training and experience
9. **Freely given fully informed consent**
10. Accurate reporting, interpretation and verification of data
11. All records to be confidential
12. Products manufactured to GMP (Good Manufacturing Practice) and used only according to the protocol
13. Systems with procedures that assure quality of every aspect to be implemented

9 | Presentation Title | Presenter Name | Date | Subject | Business Use Only



## ICH Definition

2 of 8

### **Informed Consent:**

Process by which a subject **voluntarily** confirms his/her willingness to participate in a particular trial, after **having been informed** of all aspects of the trial that are relevant to a subject's decision to participate.

**Informed consent is documented by means of a written signed and dated informed consent form.**

10 | Presentation Title | Presenter Name | Date | Subject | Business Use Only



## Information required for Informed Consent

- Trial involves research
- Purpose of trial
- Treatment with probability
- Procedures (+ invasive)
- Subject responsibilities
- Experimental aspects
- Risks/inconveniences
- Expected benefits
- Alternative
- Compensation for trial related injury
- Prorated payment
- Expenses
- Voluntary, free to withdraw
- Direct access to records
- Confidentiality
- New information timely
- Contact person
- Reasons for termination
- Duration
- Number of subjects

20 elements of IC according to GCP

11 | Presentation Title | Presenter Name | Date | Subject | Business Use Only



## ICH Definition

1 of 2

### Vulnerable subjects

**Individuals whose willingness to volunteer in a clinical trial may be unduly influenced by the expectation, whether justified or not, of benefits associated with participation, or of a retaliatory response from senior members of a hierarchy in case of refusal to participate**

12 | Presentation Title | Presenter Name | Date | Subject | Business Use Only



## ICH Definition

2 of 2

### Impartial Witness

A person who:

- is independent of the trial
- cannot be unfairly influenced by people involved with the trial
- attends the informed consent process if the subject or the subject's legally acceptable representative cannot read
- reads the informed consent form and any other written information supplied to the subject

13 | Presentation Title | Presenter Name | Date | Subject | Business Use Only



## Consent in Vulnerable Populations

- Those not capable of consenting i.e. minors/incapacitated
  - Consent is given by a legal representative
  - Subject should be informed to the extent compatible with their understanding
  - Subject should sign and date the written informed consent if capable
- Those unable to read or make their mark
  - An impartial witness should be present during the entire consent discussion and should always sign and date the consent document
- In emergency situations
  - When it is not possible to get consent from legal representative or impartial witness, the participant can be enrolled in a trial if the provisions for such are stipulated in the protocol

14 | Presentation Title | Presenter Name | Date | Subject | Business Use Only



## Considerations for Patient Understanding

- **local language**
- **use present tense**
- **use personal pronouns**
- **avoid scientific terms**
- **use short sentences**
- **avoid claims of safety, efficacy, equivalence, or superiority to similar products**
- **avoid emphasis on payment and assure level of payment is non-coercive or requires completion of trial**

15 | Presentation Title | Presenter Name | Date | Subject | Business Use Only



## Considerations for Consent – local regulatory requirements

- Legal age where parental/guardian consent not required
- Legally authorized representative
  - **for children – parent or legal guardian**
  - **for adults – legal guardian, power of attorney, spouse, adult children, next of kin**
- Certain research may require both parents' consent
- Procedures for patients who cannot read or write
- Children's assent
  - **at what age/understanding is it appropriate**
  - **written in simple language (using pictures if helpful)**

16 | Presentation Title | Presenter Name | Date | Subject | Business Use Only





## Common Problems with Informed Consent Documents

- Benefits of the research are over-stated
- Risks are not fully explained
- The alternative options are not clearly explained
- Contains exculpatory language, for example:
  - **We will not compensate you unless it is proven that your injury is the result of negligence**
  - **The sponsor will be the sole owner of the specimens and you give up any and all commercial rights to any developments resulting from this research**

17 | Presentation Title | Presenter Name | Date | Subject | Business Use Only



## Common Problems with Informed Consent Documents

- Section describing what procedures are involved in the research is too complicated
- No clear line between screening procedures and the study procedures
- Procedures do not accurately describe all relevant issues – for example:
  - **Consent may state that 1 teaspoon of blood will be drawn but does not state that this will happen 9 times over the course of two days**

18 | Presentation Title | Presenter Name | Date | Subject | Business Use Only



## Common Problems with Informed Consent Documents

- No explanation of whom subject can contact for questions:
  - **about the research**
  - **research subject's rights**
  - **in the event of a research related injury**
- Cost section does not specifically state what subjects will have to pay for

## Think about the patient/subject

- Ensure the language make sense to someone who is not in the medical profession
- Confirm that all procedures have been described
- Confirm that all risks have been describe
- Ensure there is no exculpatory language

## Conclusion

---

- Voluntary Consent is essential
- The person involved in the study should have sufficient information to make an informed choice
- The person involved in the study should have free power of choice to participate and to withdraw consent

*Thank You  
for your attention !*

Questions ?

# Concept of product life-cycle, DSUR and Safety Monitoring Board

Junko Sato, PhD  
Office of New Drug I, PMDA

APEC Preliminary Workshop on Review of Drug Development in Clinical Trials  
2007.3.17 – 21, Bangkok, Thailand



## Disclaimer

❖ *The information within this presentation is based on the presenter's expertise and experience, and represents the views of the presenter for the purposes of a training workshop*

APEC Preliminary Workshop on Review of Drug Development in Clinical Trials  
2007.3.17 – 21, Bangkok, Thailand



# Product life-cycle

---

APEC Preliminary Workshop on Review of Drug Development in Clinical Trials  
2007.3.17 – 21, Bangkok, Thailand

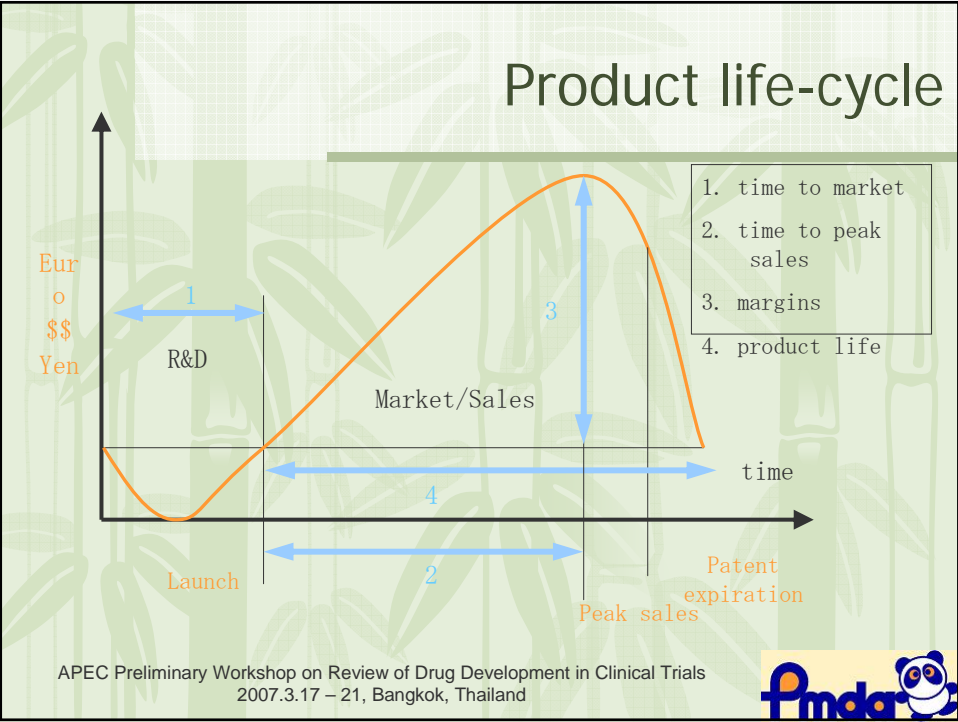
# Product Life Cycle Management Vision

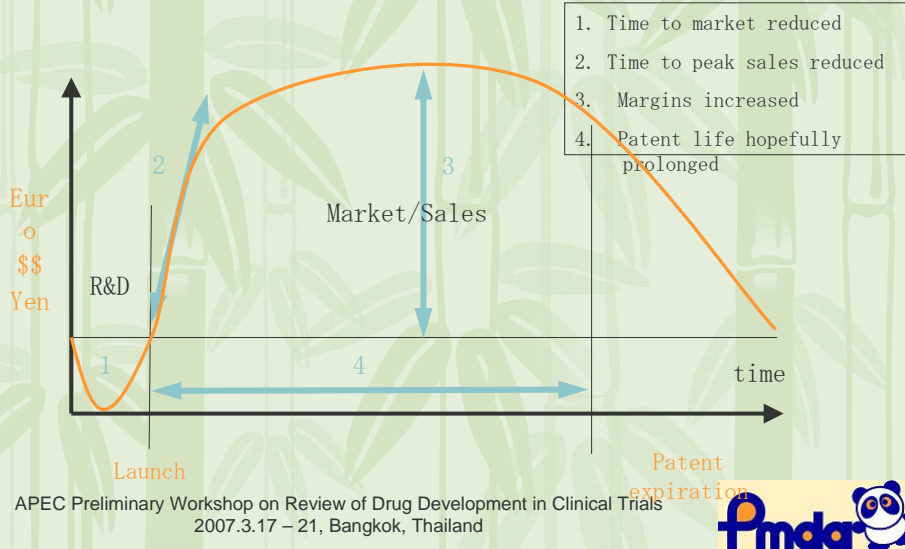

# LCM of Azithromycin in US

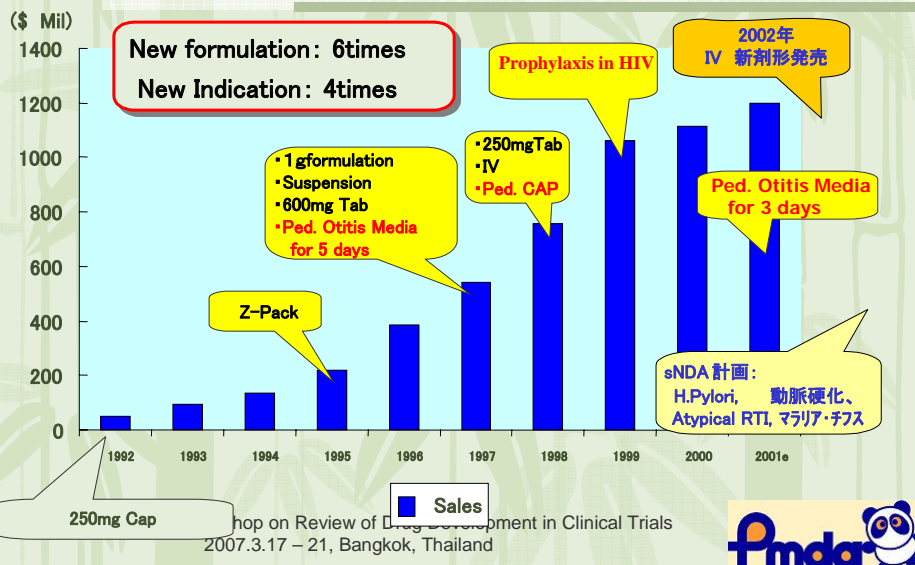

## Continuous Life-cycle management Strategy & investment of Cipro

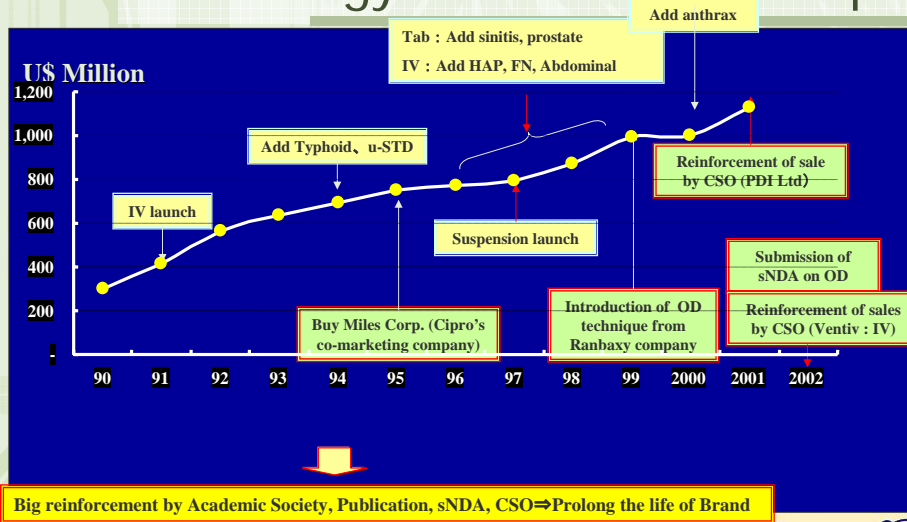

APEC Preliminary Workshop on Review of Drug Development in Clinical Trials  
2007.3.17 – 21, Bangkok, Thailand



## Trend of LCM

- ❖ New indication
- ❖ New dosage
- ❖ New formulation
  - ❖ DDS, controlled release, transdermal, etc.
- ❖ Combination drug

APEC Preliminary Workshop on Review of Drug Development in Clinical Trials  
2007.3.17 – 21, Bangkok, Thailand







## More efficacy

- ❖ Approved dosage was confirmed efficacy and safety for approved indication
- ❖ But more effective/safety dosage may be found out according to progress of science
- ❖ Courage will be needed to change dosage of a drug

APEC Preliminary Workshop on Review of Drug Development in Clinical Trials  
2007.3.17 – 21, Bangkok, Thailand



## LCM by change of dosage in Japan

- Approved dosage 100~200mg BID or TID
- Top sales in this class
- In past, efficacy depend on AUC. But according to progress of science, efficacy also depend on C<sub>max</sub>.
- Furthermore QD is effective to control resistants.



Change to 500mg QD

APEC Preliminary Workshop on Review of Drug Development in Clinical Trials  
2007.3.17 – 21, Bangkok, Thailand



## PK/PD parameter in antibiotics

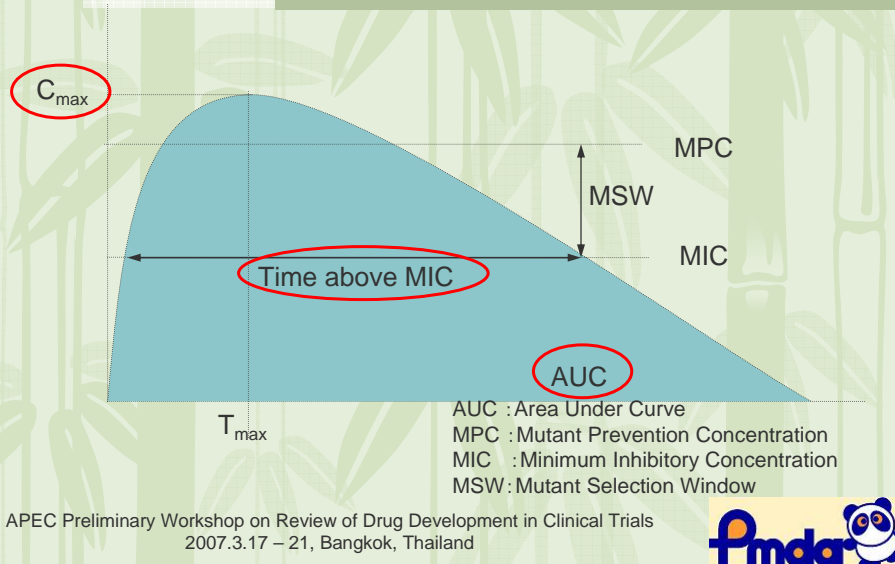

## Risk Management in LCM

- ❖ Some drugs were withdrawn by safety issue.
- ❖ Risk management is effective for LCM
  - ❖ Decrease number of ADRs
    - ❖ What is risk factor ?
  - ❖ Early detection of ADRs
    - ❖ Avoid to be severe

# Post-correspond to Pre-avoid



Corresponded after accidents



**Monitor specified safety issue  
by Clinical trials etc.**

- Pre-avoid
- Early detection

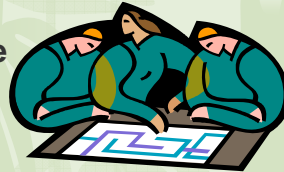

APEC Preliminary Workshop on Review of Drug Development in Clinical Trials  
2007.3.17 – 21, Bangkok, Thailand



# Development Safety Update Report (DSUR, ICH-E2F)

APEC Preliminary Workshop on Review of Drug Development in Clinical Trials  
2007.3.17 – 21, Bangkok, Thailand



# ICH-E2F Development Safety Update Report

**ICH** INTERNATIONAL CONFERENCE ON HARMONISATION OF TECHNICAL REQUIREMENTS FOR REGISTRATION OF PHARMACEUTICALS FOR HUMAN USE

Final Concept Paper  
E2F: Development Safety Update Report  
20 September 2006

## Type of Harmonization Action Proposed

It is proposed that ICH develop a guideline on periodic reporting of safety information from clinical trials. This guideline would define the preferred content, format, and timing of such reports. The CIOMS VI Working Group referred to this type of report as a Development Safety Update Report (DSUR). The DSUR would be used by industry to regularly inform appropriate stakeholders of new safety data and the evolving safety profile of drugs, vaccines, and therapeutic biologic products before they are marketed, and also when new indications, formulations, etc. are being studied for marketed products. The objective of the proposed DSUR for clinical trials would be similar to that of the Periodic Safety Update Report (PSUR) that is commonly used for marketed pharmaceutical products.

Statement of the Perceived Problem  
APEC Preliminary Workshop on Review of Drug Development in Clinical Trials  
2007.3.17 – 21, Bangkok, Thailand <http://www.ich.org/LOB/media/MODIA3372.pdf>



## Timelines

- ❖ Step 2 document: June 2008
  - ❖ Could be earlier if we have interim E2F meeting
- ❖ Step 4 document: June 2009
  - ❖ or 1 year after Step 2 document, if earlier

APEC Preliminary Workshop on Review of Drug Development in Clinical Trials  
2007.3.17 – 21, Bangkok, Thailand



## Benefits of DSUR

- ❖ Comprehensive, thoughtful annual review provides additional level of assurance of protection for patients in clinical trials
- ❖ Single DSUR for compound – provides complete picture of evolving safety profile of compound
  - ❖ Summary of Important Risks section – highlights issues to monitor (industry and regulator)
- ❖ Harmonisation of format, content and scheduling of annual reports
  - ❖ Regulators get the same information at the same time
  - ❖ Improved consistency among companies
  - ❖ Decrease in number of reports generated
- ❖ Facilities work sharing
- ❖ Harmonises with E2E and E2C

APEC Preliminary Workshop on Review of Drug Development in Clinical Trials  
2007.3.17 – 21, Bangkok, Thailand



## DSUR Guideline

(2007.11)

APEC Preliminary Workshop on Review of Drug Development in Clinical Trials  
2007.3.17 – 21, Bangkok, Thailand





# DSUR guideline

1. Introduction
  1. Objective of the Guideline
  2. Background
  3. General Principles
  4. Scope of the DSUR
2. Guidance
  1. When is a DSUR required
  2. Who is Responsible for a DSUR?
  3. Recipients of a DSUR
  4. Periodicity of Reporting
  5. Single DSUR for an Investigational Drug
  6. Reference Safety Information
  7. Update in Actions Taken for Safety Reasons
  8. Content and Format of DSUR

APEC Preliminary Workshop on Review of Drug Development in Clinical Trials  
2007.3.17 – 21, Bangkok, Thailand



# General principles

- ❖ To present a periodic review and analysis of safety information in order to;
  - ❖ Examine whether the information reported during the review period is in accord with previous knowledge of the product's safety
  - ❖ Describe new safety issues that could have an impact on the development programme or on an individual trials
  - ❖ Summarize the current understanding and management of know and potential risks

APEC Preliminary Workshop on Review of Drug Development in Clinical Trials  
2007.3.17 – 21, Bangkok, Thailand



## Objective of DSUR

- ❖ Periodic analysis during the clinical development of an investigational drug
  - ❖ evolving safety information
  - ❖ be crucial to ongoing assessment of risk
- ❖ Outline of points to be considered in preparing a DSUR
  - ❖ Its content
  - ❖ format

APEC Preliminary Workshop on Review of Drug Development in Clinical Trials  
2007.3.17 – 21, Bangkok, Thailand



## Background

- ❖ Necessity of data regarding drug safety
  - ❖ To protect the welfare of trial subjects
  - ❖ To ensure that the appropriate data are collected, especially as new safety issues are identified.
  - ❖ To be available for ongoing regulatory review and evaluation
- ❖ CIOMS Working Groups recommended the introduction of DSUR

APEC Preliminary Workshop on Review of Drug Development in Clinical Trials  
2007.3.17 – 21, Bangkok, Thailand



## Scope of the DSUR

- ❖ Concise and informative and company safety documents
- ❖ Focus on the information that assures regulators that sponsors are adequately monitoring and evaluating the safety of the drug
- ❖ Replace existing US and EU annual clinical trial reports
- ❖ Include drugs, vaccines, biologics
  - ❖ Exclude devices
  - ❖ Include entire clinical program
  - ❖ Include both commercial and non-commercial clinical trials

APEC Preliminary Workshop on Review of Drug Development in Clinical Trials  
2007.3.17 – 21, Bangkok, Thailand



## What should be summarized ?

- ❖ all completed and ongoing interventional studies, conducted by the sponsor,
- ❖ data received by the sponsor from other parties conducting clinical trials on the drug including studies conducted by co-development partners in a licensing agreement (if the scope of the licensing agreement allows for this);
- ❖ other clinical studies conducted in accordance with INDs/CTAs, e.g., pre-approval access programmes
- ❖ safety data from spontaneous reports, Phase IV studies, active surveillance programmes and registries;
- ❖ observational and epidemiological studies;
- ❖ literature reports and
- ❖ late breaking information.

APEC Preliminary Workshop on Review of Drug Development in Clinical Trials  
2007.3.17 – 21, Bangkok, Thailand





## Guideline

APEC Preliminary Workshop on Review of Drug Development in Clinical Trials  
2007.3.17 – 21, Bangkok, Thailand



## When is a DSUR required

- ❖ Submit throughout the lifecycle of the investigational drug
- ❖ Annual report

APEC Preliminary Workshop on Review of Drug Development in Clinical Trials  
2007.3.17 – 21, Bangkok, Thailand



## Who's Responsible for Preparing it?

- ❖ Whether representing a commercial or non-commercial organisation, the sponsor is responsible for the preparation.
- ❖ Non-commercial sponsor may delegate individual sponsor activities such as preparation and submission of a DSUR by making a contractual agreement in writing with another party who will prepare or submit it on his behalf.

APEC Preliminary Workshop on Review of Drug Development in Clinical Trials  
2007.3.17 – 21, Bangkok, Thailand



## Recipients of DSUR

- ❖ Primarily, regulatory authorities
- ❖ Ethics Committee/IRB or investigators, if national legislation requires.
  - ❖ Only Executive Summary

APEC Preliminary Workshop on Review of Drug Development in Clinical Trials  
2007.3.17 – 21, Bangkok, Thailand



## Periodicity of Reporting

- ❖ Submit on annual basis no later than 60 days from data lock point
- ❖ Prior to the first marketing approval of an investigational drug the data lock point should be based on the date of the first approval or authorisation to conduct an interventional clinical trial in any country.
- ❖ DIBD is analogous to the IBD for PSUR

\*DIBD : Development International Birth Date

APEC Preliminary Workshop on Review of Drug Development in Clinical Trials  
2007.3.17 – 21, Bangkok, Thailand



## Restart of development

- ❖ Development stopped or
- ❖ Never started in one region but continues in another region and then restarts in the region where it stopped
  - ❖ the next DSUR would be the one from the region where trials continued
- ❖ A sponsor has discontinued development of a drug but at a later date restarts development
  - ❖ provide a summary of the cumulative safety information from the previous development in the application for authorisation and provide an IB based on the available safety data

APEC Preliminary Workshop on Review of Drug Development in Clinical Trials  
2007.3.17 – 21, Bangkok, Thailand



## Single DSUR for an Investigational Drug

- ❖ Single DSUR include all safety data from all investigational clinical trials conducted with same investigational drug
  - ❖ All indication
  - ❖ All dosage forms
  - ❖ Intended populations
- ❖ Combination therapy
  - ❖ To be incorporated into separate section of one of the DSURs of the individual components of the combination.
  - ❖ a single DSUR to be submitted for all drugs in the study

APEC Preliminary Workshop on Review of Drug Development in Clinical Trials  
2007.3.17 – 21, Bangkok, Thailand



## Reference Safety Information

- ❖ Prior to approval in any country
  - ❖ Safety Section of Investigators Brochure
- ❖ Authorised product
  - ❖ Summary of Product Characteristics

APEC Preliminary Workshop on Review of Drug Development in Clinical Trials  
2007.3.17 – 21, Bangkok, Thailand



## Update on Actions Taken for Safety Reasons

- ❖ Refusal of authorisation of a clinical trial for safety reasons;
- ❖ Partial or complete clinical trial suspension;
- ❖ Hold or early termination of a clinical trial due to lack of efficacy or safety issues;
- ❖ Removal of a clinical hold;
- ❖ Changes to the reference safety information;
- ❖ Protocol modifications due to safety or efficacy concerns (e.g. dosage changes, changes in study entrance criteria, intensification of monitoring);
- ❖ Changes in target population or indications;
- ❖ Changes to the informed consent document relating to safety issues;
- ❖ Formulation changes;
- ❖ Failure to obtain marketing authorisation for a tested indication;
- ❖ Significant changes to the Development Risk Management Plan ( e.g. addition of a special reporting requirement, issuance of a Dear Investigator or Dear Doctor letter, plans for new safety studies.

APEC Preliminary Workshop on Review of Drug Development in Clinical Trials  
2007.3.17 – 21, Bangkok, Thailand



## DSUR and PSUR

- ❖ Once a drug is approved in any country the DIBD should be changed to coincide with the IBD, to facilitate simultaneous preparation and alignment of the DSUR with the PSUR, and simultaneous submission of the two documents to those regulators requiring both.

APEC Preliminary Workshop on Review of Drug Development in Clinical Trials  
2007.3.17 – 21, Bangkok, Thailand





## DSUR include all sources relevant to investigational drug

- ❖ all completed and ongoing interventional studies
- ❖ other parties conducting clinical trials on the drug including studies conducted by co-development partners in a licensing agreement
- ❖ other clinical studies conducted in accordance with INDs/CTAs
- ❖ safety data from spontaneous reports, Phase IV studies, active surveillance programmes and registries
- ❖ observational and epidemiological studies
- ❖ literature reports and so on

APEC Preliminary Workshop on Review of Drug Development in Clinical Trials  
2007.3.17 – 21, Bangkok, Thailand



## Progress this Week

- ❖ Revised draft Guideline sections:
  - ❖ Introduction
  - ❖ Background
  - ❖ Periodicity of Reporting
  - ❖ Single DSUR for an Investigational Drug
  - ❖ Multi-drug regimens, fixed drug combinations and drug-device combinations
  - ❖ Reference Safety Information
  - ❖ Drop-outs

APEC Preliminary Workshop on Review of Drug Development in Clinical Trials  
2007.3.17 – 21, Bangkok, Thailand





APEC Preliminary Workshop on Review of Drug Development in Clinical Trials  
2007.3.17 – 21, Bangkok, Thailand



## Safety Monitoring Board

---

APEC Preliminary Workshop on Review of Drug Development in Clinical Trials  
2007.3.17 – 21, Bangkok, Thailand



## Safety Monitoring Board

- ❖ Data safety monitoring board (DSMB)
  - ❖ To monitor safety and efficacy progress of trial through clinical trials (development)
  - ❖ Independent committee from investigators
  - ❖ Composed by MD, Statistician, pharmacist, etc.
  - ❖ Sponsor sets DSMB
  - ❖ Recommend to sponsor continuation, modification or stopping of trial

APEC Preliminary Workshop on Review of Drug Development in Clinical Trials  
2007.3.17 – 21, Bangkok, Thailand







**APEC Preliminary Workshop: Review of Drug Development in Clinical Trials**

**Session 11 – Industry Perspective  
Data Safety Monitoring Boards and Product Life Cycle**

**Susan D’Amico**  
Vice President and Global Head  
Clinical Quality Assurance

 **NOVARTIS**

© 2008 Novartis

## Disclaimer

---

- *The information within this presentation is based on the presenter's expertise and experience, and represents the views of the presenter for the purposes of a training workshop*

# Data Safety Monitoring Boards Industry Perspective



## Data Safety Monitoring Boards (DSMB)

*An independent committee established specifically to monitor data throughout the duration of a study to assess if continuation of study is appropriate scientifically and ethically.*

Situations where a DSMB should be considered:

- Trials that are long term or have large patient exposure.
- Trials that involve mortality and serious morbidity.
- On-going monitoring of emerging safety issues in a program.
- Trials that might be stopped early due to overwhelming efficacy or lack of effectiveness (futility).
- Scientific needs-information may be needed for some decisions for go- no go decisions, study trial design, or perhaps planning a future trial.
- Adaptive design- where pre-planned adaptations will be considered based on interim data as part of an adaptive design strategy.
- Health authority requests.



# Product Life Cycle Novartis Industry Perspective



## Product Life Cycle Novartis Industry Perspective

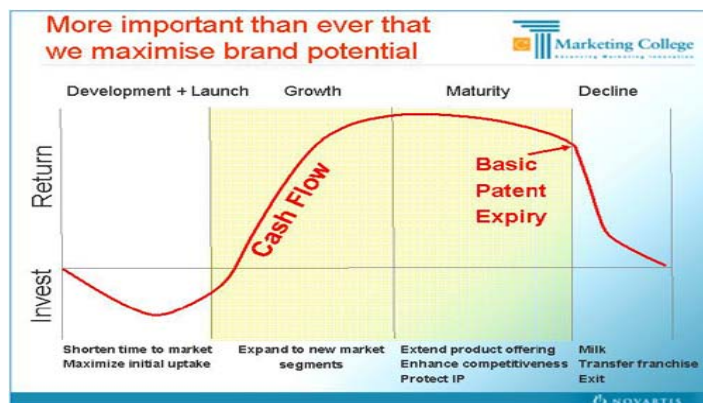

### What is Life Cycle Management?

Life Cycle Management (LCM) is the process of optimizing the value of a molecule over its whole life cycle, within the context of the overall Novartis product and project portfolio.



## Product Life Cycle Novartis Industry Perspective

---

### Why is LCM important?

Successfully developing and commercializing new pharmaceuticals is becoming more challenging, for several reasons:

- Lower R+D productivity (less new molecules; higher development costs per molecule)
- Impact of patent expiries of major products and more aggressive generic competition
- Downward pressure on prices
- Growing safety concerns
- Increasing promotional spend necessary to fund new ways to reach customers and consumers
- It is therefore more important than ever that we optimize the value of our existing products over their whole life cycle. This means striking the right balance between maximising existing brand assets and creating new ones.



---

*Thank You  
for your attention !*

Questions ?





## 12 – Pharmacogenomics

Presentation to APEC Preliminary Workshop  
on Review of Drug Development  
in Clinical Trials

Celia Lourenco, PhD,  
Manager, Clinical Group I  
Office of Clinical Trials  
Therapeutic Products Directorate

*Disclaimer: the information within  
this presentation is based on the  
presenter's expertise and  
experience, and represents the  
views of the presenter for the  
purposes of a training workshop*

## Overview

- Introduction to Pharmacogenomics (PGx) and “Individualized Therapy”
- Examples of applications of PGx
- Regulations and Guidance
- PGx requirements for clinical trials

## Blockbuster Drug Model

Because investigators have previously been unable to determine which participants will benefit from a drug, trials have had to be large enough to show statistically significant responses among all subjects



## Blockbuster Drug Model



- Failure rate in clinical trials is  $\sim 50\% = \frac{1}{2}$  cost of total development costs

- Typically efficacious in only 40 to 60 percent of patient population

## Pharmacogenomics Concept



- Ideally, physicians would test each patient **BEFORE** treatment to prevent from lack of efficacy and/or avoid adverse drug reactions

- Human Genome Sequence brought about increased understanding of tools to decipher DNA

- Costs of genomic sequencing and bioinformatic analysis are decreasing, while capabilities growing exponentially

## Pharmacogenomics Concept

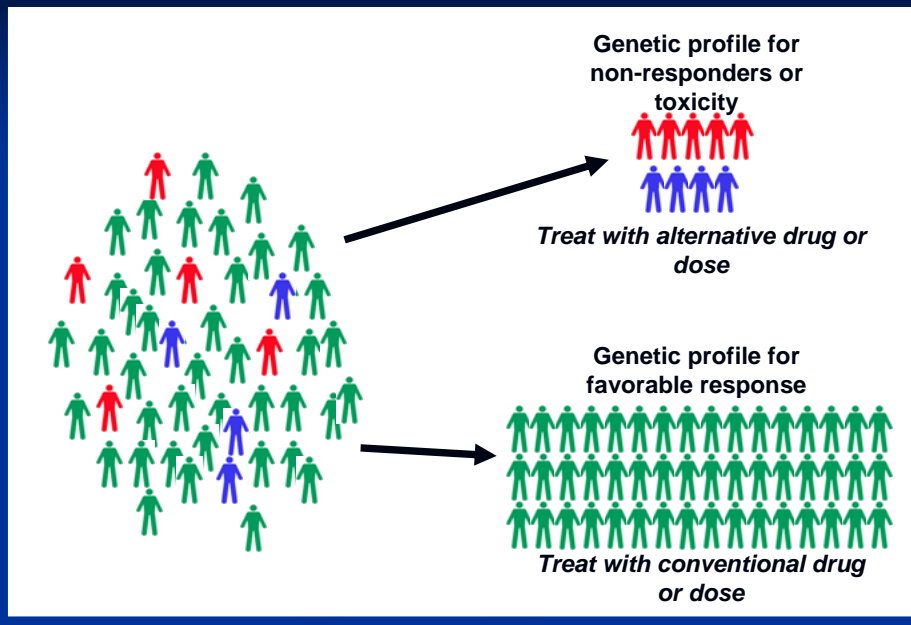

## Examples: Drug Metabolism

- CYP2C19 and CYP2D6 Variants – Poor vs extensive metabolizers
- N-acetyltransferase - slow and fast acetylators
- Deficiency of dihydropyrimidine dehydrogenase (DPD) activity - *Capecitabine*
- Glucose- phosphate dehydrogenase (G6PD) deficiency - *Rasburicase*
- Thiopurine methyltransferase deficiency or lower activity - *Azathioprine*
- Homozygous UGT1A\*28 allele - *Irinotecan*



## Examples: Drug Target

- C-KIT expression in GIST - *Imatinib*
- CCR5 -Chemokine C-C motif receptor on human T-cell - *Maraviroc*
- EGFR expression - *Erlotinib, Cetuximab*
- Her2/neu expression - *Trastuzumab*
- Philadelphia (Ph1) chromosome - *Busulfan*

## Regulatory Guidance

- **FDA:** Guidance for Industry - Pharmacogenomic Data Submissions
- **EMA:** Reflection Paper on Pharmacogenomic Samples, Testing and Data Handling
- **ICH Topic E15:** Definitions for genomic biomarkers, pharmacogenomics, pharmacogenetics, genomic data and sample coding categories
  - To ensure consistency in the terminology used by the different regions
- **Japan**
- **Health Canada Guidance:** Submission of Pharmacogenomic Information

## Definitions

- ICH E15: The study of variations of DNA and RNA characteristics as related to drug response
  
- HC Guidance:
  - Pharmacogenomics is the identification and study of genes and their corresponding products which influence individual variation in the efficacy and/or toxicity of therapeutic products, and the application of genomic information to help inform therapeutic product development and/or clinical application. This may include:
    - choosing the most appropriate therapeutic product for a patient;
    - selecting optimal dose; and/or
    - identifying those at risk for unexpected or more frequent adverse drug reactions

## PGx and Division 5 of the Regulations

- C.05.005 (e):
  - (vi) any results of clinical pharmacokinetic studies of the drug,
  - (vii) any information regarding drug safety, pharmacodynamics, efficacy and dose responses of the drug that were obtained from previous clinical trials in humans

## PGx Guidance

- *Interpretation of C.05.005 (e)(vi)(vii) :*  
Any PGx results from clinical pharmacokinetic studies of the drug as well as any information regarding drug safety, pharmacodynamics, efficacy and dose responses of the drug that were obtained from previous clinical trials in humans shall be submitted as part of the CTA in accordance with C.05.005 (e) if the results support the safety and/or efficacy of the drug for which the application is being filed.

## Considerations for Clinical Trials Involving PGx Testing

- PGx tests may be considered “medical devices”
- The main criteria for data requirements for the use of the medical device in a clinical trial application are:
  - Whether or not the test will be used to make patient management decisions in the trial (as opposed to use only in exploratory studies)
  - Stage of drug development
  - Whether or not the test is licensed

## PGx for Patient Management

- Generally, the PGx test should be licensed or an Investigational Testing Application (ITA) is required in order for the PGx test to be used in a trial
- For a PGx test that is licensed for sale in Canada, the sponsor should provide the name, description, and licence number of the device and whether the device will be used for its intended purpose
- If PGx test is not licensed, and an ITA is required, then the sponsor should include all available data that supports the analytical validity of the test
- *Under consideration:* On a case-by-case basis, the requirement for a license or ITA could be waived for early Phase I proof-of-concept trials until a later development phase; patient safety is always a deciding factor

## PGx for Exploratory Research

Authorization of the medical device is not required for PGx testing if:

- the test is not manufactured, sold or represented for *in vitro* diagnostic use; or
- the test is labelled “For Research Use Only” and is not otherwise labelled or otherwise represented for a specific diagnostic application.

## Informed Consent (1)

- Scenarios under which PGx information may be collected:
  - PGx testing carried out within the context of the main clinical trial
  - PGx testing as a sub-study that is not linked, but may be indirectly related to the main clinical trial
  - For future use (banking) in exploratory studies
- Informed consent is very important in all scenarios

## Informed Consent (2)

- The informed consent form should explain:
  - that PGx testing will be conducted and the purpose of such testing (i.e., how the PGx data will be used)
  - the sample and data coding strategy, and the storage, destruction, and security measures used for sample and data preservation to ensure confidentiality to the extent possible
  - That after anonymization, it is not possible to retrieve a subject's sample
  - the rights of the subject with regards to the PGx testing and the study overall
- Constraints and conditions and any other general guidelines set by each local Research Ethics Board / Institutional Review Committees must be respected, in addition to any applicable Federal and/or Provincial legislation

## If Filing a CTA with PGx

- Sponsors are encouraged to request a consultation meeting with Health Canada prior to submitting a CTA that contains PGx information or that uses a PGx test, especially in circumstances where the PGx test will be used to determine subject eligibility, drug dosing, or some other risk management strategy

## Conclusion

- PGx is not a new topic but facilitated by new tools
- Several Guidance documents have been developed by different regions
- We are now seeing CTAs with a PGx component
- Co-approval of an ITA for the PGx test may be required
- Informed consent is one of the most important aspects of PGx testing

## References

Health Canada Pharmacogenomic Guidance	<a href="http://www.hc-sc.gc.ca/dhp-mps/alt_formats/hpfb-dgpsa/pdf/brgtherap/pharmaco_guid_id_2007-02_e.pdf">http://www.hc-sc.gc.ca/dhp-mps/alt_formats/hpfb-dgpsa/pdf/brgtherap/pharmaco_guid_id_2007-02_e.pdf</a>
FDA Pharmacogenomics Guidance	<a href="http://www.fda.gov/cber/gdlns/pharmdtasub.pdf">http://www.fda.gov/cber/gdlns/pharmdtasub.pdf</a>
EMA Pharmacogenomics Guidance	<a href="http://www.emea.europa.eu/pdfs/human/pharmacogenetics/20191406en.pdf">http://www.emea.europa.eu/pdfs/human/pharmacogenetics/20191406en.pdf</a>
FDA Table of Valid Genomic Markers	<a href="http://www.fda.gov/cder/genomics/genomic_biomarkers_table.htm">http://www.fda.gov/cder/genomics/genomic_biomarkers_table.htm</a>

L1

 Health Canada Santé Canada

**Therapeutic Products Directorate** **Direction des produits thérapeutiques**

Health Products and Food Branch Direction générale des produits de santé et des aliments



**13 – Essential Elements in Clinical Trial Assessment**

**Presentation to APEC Preliminary Workshop on Review of Drug Development in Clinical Trials**

**Celia Lourenco, PhD,  
Manager, Clinical Group I  
Office of Clinical Trials  
Therapeutic Products Directorate**



 Therapeutic Products Directorate Direction des produits thérapeutiques

*Disclaimer: the information within this presentation is based on the presenter's expertise and experience, and represents the views of the presenter for the purposes of a training workshop*



## Slide 1

---

L1

Lourenco, 28/01/2551

## Overview

- Sufficient evidence (safety, efficacy, and quality)
- Enabling regulatory framework
- Good review practices when assessing a clinical trial
- Challenges & strategies
- Lessons learned from the Canadian experience

## Sufficient Evidence

- Sufficient evidence signifies a positive benefit-to-risk ratio based on a sum of all of the following:
  - Acceptable Quality (CMC) for the phase of development
  - Acceptable supporting nonclinical and clinical data (as applicable) for the phase of development, type of drug and/or disease target
  - Acceptable protocol and informed consent form for the proposed trial
  - Maintenance of the positive benefit/risk ratio during the conduct of the trial through safety monitoring of the trial as well as other ongoing trials with the drug ('product life-cycle' approach)

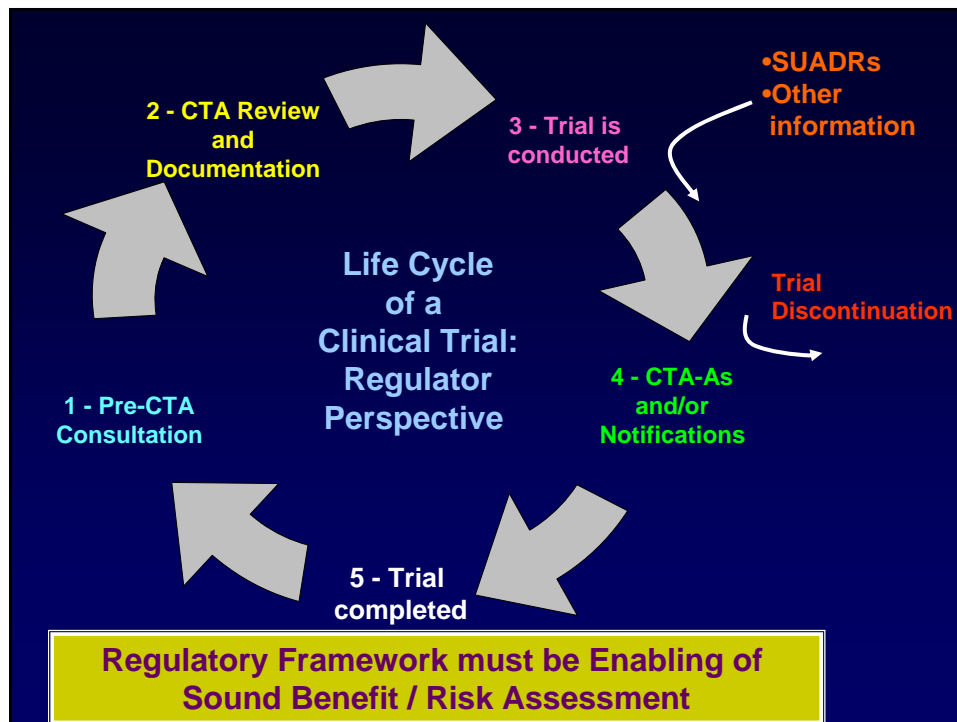

Therapeutic Products Directorate      Direction des produits thérapeutiques

## Regulatory Framework

- Regulations must aim to protect clinical trial subjects and enable sound benefit / risk assessment, without unduly restricting research and access
- Regulatory requirements should take into consideration the global context
- Globalization: adopt international guidelines where possible
- Address regional-specific issues by developing region-specific guidelines
- Guidance documents on process, format, and content, of clinical trial applications should be available

## Good Review Practices Overview

- Regulatory expertise
- Scientific expertise
- Time management
- Documentation
- Systematic approach to review
- Review of subsequent information – life cycle approach

## Good Review Practices (1)

- Regulatory expertise:
  - Know the applicable regulations
  - Know the applicable guidelines
  - Know the difference between regulations and guidelines
    - Regulations are mandatory requirements
    - Guidelines are supported by regulations but allow flexibility in requirements when acceptable scientific rationales are presented
  - Check prior decisions that were precedence-setting and ensure consistency
  - Use a case-by-case approach for infrequent scenarios

## Good Review Practices (2)

- Scientific expertise (CMC):
  - Know the principles of CMC and GMP for pharmaceuticals or biologics
  - Know the basic quality requirements and considerations for the type of drug product and clinical trial stage in question (quality is linked to clinical application)
  - Consult with colleagues and read the latest literature related to the product area

## Good Review Practices (3)

- Scientific expertise (clinical):
  - Know how the disease is treated and the clinical practice guidelines relevant to the disease area
  - Read the latest literature on the disease
  - Compare the information with the background and rationale provided by the sponsor
  - Consult with internal or external experts in the disease area as needed
  - If unclear about the rationale for the study, ask the sponsor for additional information

## Good Review Practices (4)

- Time management:
  - A good review takes time, therefore, do the preliminary assessment as soon as possible taking into consideration the time available
  - Prioritize applications that may present problems following initial overview / screen
  - Major issues should be communicated to the sponsor as early as possible to allow time for discussion and resolution
  - Strive for issuing requests for additional information once the entire data package has been reviewed

## Good Review Practices (5)

- Documentation:
  - Documentation of the review of the clinical trial should be accurate and concise, including information about the drug, sponsor and manufacturer, protocol number, title of the study, and the regulatory tracking number(s) assigned to the clinical trial application
  - Templates filled out by the sponsor can be used in preparing the review report

## Good Review Practices (6)

- Documentation (continued):
  - Both the clinical and quality (CMC) review reports should include a section where the reviewer summarizes the essential quality and clinical elements in the proposed clinical trial presented by the sponsor, along with the reviewer's comments and thought processes in the analysis of the information
  - The reviewer's recommendation should be clearly supported by a scientific and/or clinical assessment of the overall benefit-to-risk ratio

## Good Review Practices (7)

- Documentation (continued):
  - Any deficiencies identified during review should be described along with the outcome of all discussions with colleagues, managers, experts, or communications with the sponsor to resolve the deficiencies
  - All communications with the sponsor (e.g., faxes, letters, emails, records of telephone conversations) should be appended to the review report

## Good Review Practices (8)

- Documentation (continued):
  - Review reports should be signed by the reviewer and dated along with the recommendation for disposition of the clinical trial in line with the applicable regulations:
    - The clinical trial application **is** considered to comply with section C.05.006(1)(a) of the Food and Drug Regulations, and a **No-Objection-Letter** is recommended
    - The clinical trial application **is not** considered to comply with section C.05.006(1)(a) of the Food and Drug Regulations, and a **Not-Satisfactory-Notice** is recommended for the following reasons:

## Good Review Practices (9)

- Electronic documents:
  - Review reports should be saved electronically on a shared drive for ease of access and reference when subsequent applications, such as amendments, are filed by the sponsor
  - The investigator's brochure should also be kept electronically for quick access if needed (such as when a safety issue arises through serious ADR reporting)



## Good Review Practices (10)

- Approach to review is a systematic approach:
  - Review of the dossier should begin with an assessment of the prior experience with the drug, including nonclinical data
  - The CMC data requirements should always be linked to the clinical trial context in question
  - Nonclinical data has greater impact on initial trials as compared to later development confirmatory trials, but is still important with regards to safety at later stages (e.g., results of long-term carcinogenicity, reproduction toxicity, fetal development, fertility studies, etc.)
  - The proposed trial should be supported by the quality (CMC) package and nonclinical program, as well as by previous human studies as applicable

## Good Review Practices (11)

- Approach to review of the Protocol:
  - Study design, population, sample size, dosage regimen, treatment duration, and the safety and efficacy variables must be valid, supported by data, and make scientific and clinical sense
  - Close attention should be paid to the safety monitoring, which should be appropriate for the drug, trial, and subject population
  - Check for measures to prevent adverse events (e.g., appropriate eligibility criteria and laboratory or other safety assessments), **as well as** measures to manage AEs should they arise (e.g., rescue medication, drug discontinuation, etc.), **and** measures to manage potential AEs after study termination (e.g., dose tapering to avoid drug withdrawal symptoms)

## Good Review Practices (12)

- Approach to review of the Protocol:
  - The need for oversight by an independent data safety monitoring board (DSMB)
    - pivotal trials, trials with drugs that have the potential to induce unacceptable toxicity, trials where mortality is the primary endpoint, etc.
  - The level of safety monitoring and risk mitigation measures should be commensurate with the risk of the drug under the conditions of the trial

## Good Review Practices (13)

- Statistical considerations:
  - Ensure the study design, including control group, are acceptable
  - Validated primary endpoint
  - Sample size calculation takes into account:
    - Multiplicity in primary endpoints
    - Acceptable margins of clinical significance in non-inferiority trials and superiority trials
    - Interim efficacy analysis
  - Planned statistical tests and interim analyses should be described and justified

## Good Review Practices (14)

- Informed consent review:
  - Purpose of the trial, and that it involves research
  - Visits, tests, and procedures
  - Potential risks are explained; AEs listed
  - Anticipated benefits
  - Alternate available treatment options are described
  - Subject's right to withdraw at any time
  - Access to medical records by regulatory authorities
  - Vulnerable subjects
    - Consent by a caregiver
    - Consent by parent / legal guardian
    - Assent
  - REB also reviews the consent form from a safety and ethical perspective

## Good Review Practices (15)

- Overall approach to review:
  - The review should aim to identify the major issues, which would lead to a clinical trial rejection
    - *"See the forest through the trees!"*
      - Major safety issues are paramount
      - Regulatory issues can present dilemmas, but a patient-centred benefit/risk approach should be used, when applicable
  - Integrate the findings from the entire body of scientific, nonclinical, and clinical evidence provided by the sponsor, but check also the literature, and the serious unexpected ADRs that have been reported to the regulator for the drug under study ("product life-cycle")

## Good Review Practices (16)

- Review of amendments:
  - The amendment should be supported by a sound rationale from the sponsor
  - Protocol text changes should be clearly identified
  - Changes to CMC should be supported by the necessary data
  - Review should assess
    - overall impact on safety, including monitoring
    - altered statistical analyses plans, including interim analyses
    - impact on evaluation of efficacy
    - impact on informed consent form
    - any SUADRs that have been reported

## Good Review Practices (17)

- Review of notifications:
  - Changes to the protocol or CMC should be clearly identified, and include a rationale for the notification
  - Assess impact on:
    - safety of trial subjects, including monitoring
    - evaluation of efficacy
    - informed consent form
    - A review of SUADRs may be warranted

## Good Review Practices (18)

- Review of SUADRs:
  - Integrate clinical trial reports with post-market reports
  - Epidemiological approach to the review
    - Baseline prevalence / predisposition of the patient population
    - Total number of subjects treated and duration of treatment
  - Recognize the limitations in the data presented in ADRs (e.g., comorbidities, concomitant medications, insufficient follow-up)
  - But remember the “precautionary principle”: if concerned about a potential signal, pursue further

## Good Review Practices (19)

- Review of SUADRs:
  - Check the potential mechanism of action
  - Do other drugs in the same class display similar ADRs?
  - Is there dependence on time, dose?
  - Is there evidence from de-challenge ↔ re-challenge?
  - Check the investigator’s brochure, previous protocols filed for the drug, and the literature

## Good Review Practices (20)

- Review of SUADRs:
  - The review should determine:
    - Potential causality
    - Whether the qualified investigators and the trial subjects should be informed of new risk information
    - Whether any new risk mitigation measures are required
    - Whether the clinical trial documents should be revised
    - Whether the study should be discontinued
  - Findings are discussed with colleagues, managers, etc., and discussed with the sponsor to determine the acceptable course of action

## Good Review Practices (21)

- Premature discontinuations should include a sound rationale from the sponsor and indicate:
  - The impact on planned or ongoing trials
  - That all investigators, including those of other ongoing trials, have been informed
  - That all left-over trial drug has been retrieved
- The review is aimed at assessing:
  - Impact on the safety of trial subjects from the discontinued trial, as well as patients in ongoing or planned trials
  - Impact on informed consent forms
  - Whether the sponsor fulfilled the regulatory requirements as stated above

## Challenges

- A variety of types of clinical trials signifies that a small group of clinical reviewers have to cover a broad knowledge base on different disease areas, which has the potential to lead to ill-informed decisions: “**ignorance of ignorance**”
- Increased complexity in science, types of products, and treatment of disease (e.g., gene therapies, product combinations, nanotechnologies)
- Despite the degree of complexity, reviewers have a short time frame to arrive at a review recommendation

## Strategies (1)

- Always approach a review with a perspective of safety
  - Regulatory requirements must be met
  - Alternate approaches to guidelines could be acceptable, however, the reviewer should ask for a rationale from sponsors if there is inconsistency between the sponsor’s proposal and the guidelines
- Question your knowledge, and discuss issues with colleagues and managers: **do not work alone!**
- Maintain, and make use of, internal expertise or established external expertise such as scientific advisory committees

## Strategies (2)

- Review the decisions by other regulators
- Discuss issues or concerns with sponsors
- Others will also be reviewing the trial, including, but not limited to:
  - REBs
  - Qualified investigators
  - DSMB
- Record decisions for future reference
- Keep-up with the science

## New Clinical Trial Regulations: Canadian Experience (1)

- New regulations typically go through extensive internal and external consultations before implementation
- But once implemented, they still need to be interpreted for:
  - The sponsors who have to meet the regulatory requirements
  - The public servants who have to put the regulations into practice
  - New stakeholder groups that may surface
- Important to:
  - Develop and release guidance documents at the time of implementation of the regulations
  - Be aware and address new scope of the regulations



## Canadian Experience (2)

- Division 5 of the Canadian regulations is only 6 ½ years old; previous regulations were from the early 60's:
  - Main changes brought by new regulations were:
    - Incorporating GCP into regulations
    - Broader scope, encompassing off-label trials
    - Inspection program
- Although the regulations appear fairly straightforward, it can be a challenge to translate regulations into practice
- Impact of new regulations is really measured after they are implemented and have been in effect for some time (e.g., RIAS – 3-5 years)

## Canadian Experience (3)

- Implementation of the inspection program:
  - Utilized a phased-in approach starting with a confidence-building voluntary phase (January 1, 2002)
  - Mandatory phase with 2% of clinical trials inspected and trials chosen using a risk-based approach (started January 1, 2003)
  - Interpretation of:
    - Record-keeping requirement of 25 years
    - Labelling of drug products
    - Who can act as the importer
- Lack of clarity over the interpretation of the regulations can lead to inconsistency, and requesting unnecessary information or insufficient information from sponsors

## Canadian Experience (4)

- Regulations impact more than just the pharmaceutical company sponsor
  - Qualified investigators / institutions and their staff
  - Research ethics boards
  - Subjects and patients
  - Health care and access to drugs
  - Investigators / Institutions as sponsors
  - Other research groups (e.g., positron-emitting radiopharmaceuticals)
- When implementing new regulations, need to ensure that downstream effects are initially considered, and measured by consulting with all affected stakeholders, in order to make informed decisions on how to move forward

## Regional / Global Impact

- When developing regulations, consider:
  - What are the disease areas of interest (what can your population offer)?
  - What can your health care system offer?
  - What is the status of investigator/institution-driven research in your country?
  - What frameworks are in place for ethical review of human research and protection of clinical trial subjects?
  - What are sponsors looking for in your country?
- Prepare your regulatory framework, and scientific expertise accordingly

**If not there already,  
you are on a path to success!**

- Consulting with other regulators
  - Looking for best practices
  - Looking for lessons learned

**Thank You!**

## Session 14: Proposed Topics for the Advanced workshop

This session opened for all participants to suggest or comment on the topics or interesting areas for the advanced workshop on review of drug development. The advanced workshop was planned to be conducted for 5 days in August 2008. However, speakers commented that it was rather short time for preparation. Thailand as hosting economy accepted that and would consider to reschedule the workshop to October or November 2008. The participants should be the ones, who attended the preliminary workshop on 17-21 March 2008.

In term of workshop agenda and topics, the first day should be devoted for group discussion and information sharing to

- Follow up from the Preliminary Workshop (Progress)
  - Regulatory Infrastructure
  - Best Practice Sharing
  
- Review of preliminary course topics
  - How to set up review operation

At least 3 days should be devoted for training on assessment by using lectures, exercises, and discussion. The trainees and participants suggested various advanced topics as follows:

- Quality aspects i.e. CMC assessment template
- Vulnerable populations + exercise on inform consent
- First in Human in high risk trials
- Adaptive clinical trial + protocol exercises
- Dose selection /escalation
- Global drug development
- Pharmacogenomics
- More in methodology
- Statistics
- How to interpret data
- Pharmacovigilance e.g. SUADRs, how to monitor and analysis
- Biologics

- Biologic-specific considerations e.g. vaccine(new vaccine)?, cell/tissue therapy (gen. considerations)
- Biosimilar
- DSMB
- Ethical Review
- Medical devices(brief)

The last day is for discussion and conclusion. Special issues might be addressed on the last day as well.

Thailand has collected all recommendations comments to further develop the workshop agenda together with our consultants. Thailand has realized that 5 days were not enough to cover all suggested topics. However, Consulting economies and Thailand will do our best to accommodate the requests and develop the workshop agenda.

---

Part III.  
Participants

## List of Participants

1. Mrs Jamilah Metussin

Organisation/Affiliation: Department of Pharmaceutical Services, Ministry of Health Brunei  
Darussalam

Address: 2nd Floor Ministry of Health Building, Commonwealth Drive,  
Bandar Seri Begawan 883910, Brunei Darussalam

Daytime Phone: +673 223 0001 / +673 223 0041

Fax: +673 2 230 001 / + 673 2 230 041

Email: Jamilah\_metussin@yahoo.com

2. Mr Luis Brito Rosales

Organisation/Affiliation: INSTITUTO DE SALUD PUBLICA DE CHILE

Address: AVENIDA MARATON 1000 ÑUÑO A SANTIAGO

Daytime Phone: 56 – 2-3507302

Fax: 56-2-3507598

Email: lbrito@ispch.cl

3. Mr Miguel Gonzalez Guerra

Organisation/Affiliation: INSTITUTO DE SALUD PUBLICA DE CHILE

Address: AVENIDA MARATON 1000 ÑUÑO A SANTIAGO

Daytime Phone: +56 – 2-3507638

Fax: +56-2-3507574

Email: magonzalez@ispch.cl

4. Mrs Rina Apriani

Organisation/Affiliation: National Agency of Drug and Food Control – Indonesia

Address: Jl. Percetakan Negara No. 23 - Jakarta

Daytime Phone: +62-21-4245459 (116)

Fax: +62-21-42885404

Email: penilaianobat@pom.go.id

5. Mrs Lela Amelia

Organisation/Affiliation: National Agency of Drug and Food Control - Indonesia

Address: Jl. Percetakan Negara No. 23 - Jakarta

Daytime Phone: +62-21-4245459 (116)  
Fax: +62-21-42885404  
Email: penilaianobat@pom.go.id

6. Ms NORSHIDA KASIM

Organisation/Affiliation: NATIONAL PHARMACEUTICAL CONTROL BUREAU, MINISTRY OF HEALTH MALAYSIA

Address: JALAN UNIVERSITI, P.O. BOX 319, 46730 PETALING JAYA, SELANGOR, MALAYSIA

Daytime Phone: +60378835583  
Fax: +60379551030  
Email: shida@bpfk.gov.my

7. Mr ZARIL HARZA ZAKARIA

Organisation/Affiliation: NATIONAL PHARMACEUTICAL CONTROL BUREAU, MINISTRY OF HEALTH MALAYSIA

Address: JALAN UNIVERSITI, P.O BOX 319, 46730 PETALING JAYA, SELANGOR, MALAYSIA

Daytime Phone: +603-78835582  
Fax: +60379551030  
Email: zaril@bpfk.gov.my

8. Dr Kamaruzaman Saleh

Organisation/Affiliation: National Pharmaceutical Control Bureau, Ministry of Health Malaysia

Address: Lot 36, Jalan Universiti, 46730 Petaling Jaya, Selangor, Malaysia  
Daytime Phone : +603-78835581  
Fax: +603-79551030  
Email: kazman@bpfk.gov.my

9. Dr Abdulmohsen Al rohaimi

Organisation/Affiliation: Saudi Food & Drug Authority ( SFDA) – DRUG SECTOR

Address: 3292 Northern Ring Rd – Al Nafal District  
Riyadh 13312 – 6288  
Saudi Arabia



DaytimePhone +69912759222  
Fax: +96612757195  
Email: ahrohaimi@sfda.gov.sa

10. Ms Diana Koh

Organisation/Affiliation: Health Sciences Authority, Singapore....  
Address: 11 Biopolis Way #11-03 Helios, Singapore 138667.  
Daytime Phone: +65 6866 3447  
Fax: +65 6478 9034  
Email: Diana\_Koh@hsa.gov.sg

11. Dr Xiaofeng Wu

Organisation/Affiliation: Health Sciences Authority, Singapore.  
Address: 11 Biopolis Way #11-03 Helios, Singapore 138667  
Daytime Phone: +65 6866 3409  
Fax: +65 6478 9034  
Email: wu\_xiaofeng@hsa.gov.sg

12. Dr Tharnkamol Chanprapaph

Organisation/Affiliation: New Drug Section, Drug Control Division, Food and Drug Administration, Ministry of Public Health, Thailand  
Address: Tiwanont Road, Mueng, Nonthaburi 11000, THAILAND  
Daytime Phone: +66 2 5907196  
Fax: +66 2 5907204  
Email: tankamol@fda.moph.go.th

13. Mr Morakot Papassiripan

Organisation/Affiliation: Biologics Section, Drug Control Division, Food and Drug Administration, Ministry of Public Health, Thailand  
Address: Tiwanont Road, Mueng, Nonthaburi 11000, THAILAND  
Daytime Phone: +66 2 5907028  
Fax: +66 2 5918463  
Email: morakot@fda.moph.go.th

14. Mrs Tasanee Lorchaivej

Organisation/Affiliation: Biologics Section, Drug Control Division, Food and Drug Administration, Ministry of Public Health, Thailand

Address: Tiwanont Road, Mueng, Nonthaburi 11000, THAILAND

Daytime Phone: +66 2 5907028

Fax: +66 2 5918463

Email: nang@fda.moph.go.th

15. Dr Yuppadee Javroongrit

Organisation/Affiliation: International Affairs and Investigational Drug Section, Drug Control Division, Food and Drug Administration, Ministry of Public Health, Thailand

Address: Tiwanont Road, Mueng, Nonthaburi 11000, THAILAND

Daytime Phone: +66 2 590 7061

Fax: +66 2 5918390

Email: yuppbkk@fda.moph.go.th

16. Ms Charunee Krisnaphan

Organisation/Affiliation: International Affairs and Investigational Drug Section, Drug Control Division, Food and Drug Administration, Ministry of Public Health, Thailand

Address: Tiwanont Road, Mueng, Nonthaburi 11000, THAILAND

Daytime Phone: +66 2 590 7061

Fax: +66 2 5918390

Email: charunee@fda.moph.go.th

17. Ms Akanid Wapeewuttikorn

Organisation/Affiliation: International Affairs and Investigational Drug Section, Drug Control Division, Food and Drug Administration, Ministry of Public Health, Thailand

Address: Tiwanont Road, Mueng, Nonthaburi 11000, THAILAND

Daytime Phone: Phone 02 – 590 7061

Fax: +66 2 5918390

Email: akanid@fda.moph.go.th

18. Mrs Yaowapa Srabua

Organisation/Affiliation: International Affairs and Investigational Drug Section, Drug Control Division, Food and Drug Administration, Ministry of Public Health, Thailand

Address: Tiwanont Road, Mueng, Nonthaburi 11000, THAILAND

Daytime Phone: +66 2 590 7167  
Fax: +66 2 5918390  
Email: yaobuna@fda.moph.go.th

19. Dr. Santad Chanprapaph

Organisation/Affiliation: Faculty of Pharmaceutical Sciences, Chulalongkorn University  
Address: Phayathai Road, Patumwan Bangkok  
Daytime Phone: 02-218 8319  
Fax: 02-218 8324  
Email: schanprapaph@yahoo.com

20. Mr Do Minh Hung

Organisation/Affiliation: Drug Administration of Viet Nam  
Address: 138 A, Giang Vo Str. – Ba Dinh Dist. – Ha Noi – Viet Nam.  
Daytime Phone: +84-4-8230794  
Fax: +84-4-8234758  
Email: minhhung1711@yahoo.com

Part IV.

---

Questionnaire Survey Results

## Questionnaire Survey Results

Project Code: CTI24/2007

Project Title: Capacity Building for Drug Regulatory  
Agencies on Clinical Trial and Good  
Clinical Practice

Workshop Preliminary Workshop : Review of  
Drug Development in Clinical Trials

Bangkok, Thailand 24th June 2007

Number of respondents was 16 among 20 participants.

### **Question (a): How have you or your economy benefited from the project?**

- The course strengthened the basic principles in clinical trial review and provided better understanding on drug development
- The course have a better picture how to evaluate clinical trial products and thus provide me confidence
- Knowledge and confidence in evaluating clinical trial product will improve time-line and acception of more trials to be done in my country
- To increase number of Indonesia sites, which are involved in the global pivotal studies as Indonesia have existing regulations for clinical trials
- I have gained a lot of new knowledge from this workshop, which is relevant and would be very beneficial for preparation of guidelines for clinical trials in Brunei Darussalam
- This was an excellent opportunity to network with regulators from APEC economies and will facilitate future collaborative projects where appropriate
- I gained a deeper understanding of the CTA process in Canada and Japan, which would be useful information to refine the current clinical trial regulatory framework in Singapore in the future
- I could pick up some gaps between my own economy and other regulatory agencies, such as CMC, GCP inspection for clinical trials
- Although Thai FDA doesn't have full clinical trial regulatory framework, this workshop gave us useful information and idea to develop new system in the near future

- The workshop gave us examples of how to apply some of ICH technical guidelines to assist in assessment of clinical trial protocol
- I learned other economies' challenges and strategies to regulate clinical trials and also lessons on new regulation
- I would apply the knowledge learned from this course to my work on new drug evaluation
- Chile is very interested to develop the regulation of clinical trials, particularly the scientific investigation

**Question (b): What new skills, knowledge, or value have you gained?**

- The importance of public agency in the development of clinical trial and different area of ethical review
- Principles of Clinical Trial Phase I-III
- Procedures of Clinical trial application in different economies
- Introductory knowledge of CMC review of clinical trial products
- Evaluation/Assessment of Clinical Trial Application (Phase I-III) e.g. protocol, informed consent
- Concept of product life cycle
- Pharmacogenomics
- Development Safety Update Report and its application
- Other economies' strategies and challenges
- Clinical trial regulation
- Pharmaceutical industry's and other's perspectives regarding clinical trial
- Various requirements and guidelines needed in assessment of a clinical trial protocol and related documents
- Qualification of evaluator
- Sharing experiences has given us ideas on how we can improve our system

**Question (c): What, if any, changes do you plan to pursue in your home economy as a result of the project?**

- Improve the existing clinical guidelines
- Improve or develop evaluation of clinical trial application
- Improve regulation system for clinical trial to in-line with international standards e.g. CTA procedure, assessment of protocol

- Knowledge obtained will be presented to other relevant officers
- I will start to scientifically evaluate clinical trial protocol
- We will consider undertake more detailed CMC review and a program for GCP Inspection
- To improve system and timeline in clinical trial evaluation and ultimately my country will become a hub in clinical trials in this region
- Improve CTA, consent form, protocol requirement, and clinical trial assessment
- Develop clinical trial assessment criteria and form
- Improve clinical trial inspection

**Question (d):What needs to be done next? How should the project be built upon?**

- The next project should provide
  - o the advanced course of clinical trial assessment and may based on classification of therapy and specific requirements
  - o non-clinical study or pre-clinical study assessment e.g. details of different types of studies, what types of additional testing should be carried, how to interpret the pre clinical data
  - o in depth CMC review for both pharmaceuticals and biologics
  - o Power of statistical analysis to determine numbers of subjects
  - o dose selection
  - o data safety monitoring & Pharmacovigilance in clinical trial
  - o Review of Biologics e.g. vaccines, cell tissue therapies
  - o Special considerations in clinical trials involving special product groups e.g. traditional medicine, medical devices
  - o Adaptive design
  - o GCP Inspection
  - o more details on ICH guidelines
  - o more hands-on exercises

**Question (e): Is there any plan to link the project s outcomes to subsequent collective actions by fora or individual actions by economies?**

- To encourage more clinical trials to be done in my country which will also benefit the economic of the country

- To establish committee to evaluate current situation in my country and implement recommendation
- To establish safety board
- To conduct more training or workshop related with clinical trial in my country to produce more good evaluator in clinical trial approval/monitoring and then to encourage more clinical trials to be done in my country
- To share information and experience in the region and among my colleagues
- To build clinical trial assessment in my country
- To create projects for my country on CMC review, GCP, and Safety managements for clinical trials
- To conduct more training and workshop on clinical trial evaluation and also GCP Inspection

**Question (f): Please use the same scale to rate the project on an overall basis.**

- [5] (good) : 16 (100%)
- [4] : 0
- [3] : 0
- [2] : 0
- [1] (poor) : 0

**Question (g):What is your assessment of the overall effectiveness of the project?**

- The project is very effective with qualified speakers, good training programme, lessons, discussion, case studies, and interactions between speaker and trainees.
- I get useful knowledge, hopefully they can be implemented
- Quality (CMC) considerations, and Clinical Trial Phase I, II, III assessment
- Contents covered, speakers' expertises, organization effort, and handouts
- It has been a very fruitful meeting. The topics were directly relevant and addressed real regulatory issues that we face
- The information presented are very informative and would provide a useful source as future reference and knowledge and is very beneficial indeed
- Overall the project/workshop is of great value to developing countries to better understand how clinical trials works in the point of view of industries as well as health authorities
- It is very cost-effective, the trainees gain knowledge, better understanding in regulatory framework, between regulators or network



- Well organized, great materials and topics selected

**Question (h): Was the project content: (Check One):**

- Just Right (14)
- Too Detailed (0)
- Not Detailed Enough (1)
- N/A(1)

**Question (i): Please provide any additional comments. How to improve the project, if any?**

- The project already conducted the workshop successfully
- I suggest a special topic on how to evaluate the statistical results
- The workshop was excellent. In the future workshops, should maintain the balance of representation from industry and regulatory authority and the balance of lectures VS hands-on exercises
- It is an appropriate content for the first course in this topic. It provides fundamental knowledge to clinical trial and how to assess the protocol in order to protect the consumer whereas get the scientific sound
- More exercise on evaluation of informed consent and protocols of a clinical trial would be very helpful to improve understanding of requirements and applying knowledge that had been provided through the presentations
- Keep in touch beyond the workshop in order to share more information and experiences from country to country (by email)
- Provide the checklist for evaluation of clinical trial assessment
- Speakers should provide an example of how to review and differentiate a good case study and a not good case study
- Overall the programme is just right, however it would be better to get speaker who can converse well in English to get better input from the trainers in terms of understanding the topics being discussed
- Should provide more detail in some issue/topics and more examples
- Clinical Trial report assessment and point to consider
- Cover variety topics according to the needs
- Need more about country's experience in clinical trials

- For the exercises session, if the detailed information on the drug registration dossier can be provided, it may make better understanding and more experience on CT assessment
- May speaker should provide an example of how a good review was done.
- Providing a checklist so that review has a better guide